



*An Online CPD Course
brought to you by
CEDengineering.ca*

Heat Pumps for Heating and Cooling

Course No: M06-047

Credit: 6 PDH

A. Bhatia

CED CANADA
engineering.ca
CPD FOR THE PROFESSIONAL

Continuing Education and Development, Inc.

P: (877) 322-5800

info@cedengineering.ca

www.cedengineering.ca

HEAT PUMPS FOR HEATING AND COOLING

A heat pump is an electric device used to pull heat out of air, ground or water and transfers it to the building. Heat pumps and air conditioners operate in a very similar way; the difference is that the heat pump cycle can be reversed to either heat or cool a controlled space. Some heat pumps are designed to heat water instead of air. These heat pumps are used in conjunction with spas, pools and hydronic/radiant heating systems.

Heat pumps also work extremely efficiently, because they simply transfer heat, rather than burn fuel to create it. They work best in moderate climates, so if you don't experience extreme heat and cold in your location, then using a heat pump instead of a furnace and air conditioner could help you save a little money each month.

This course explains the design, types and application of heat-pumps for residential and small commercial buildings. The course is divided into five (5) chapters.

CHAPTER - 1: OVERVIEW OF HEAT PUMPS

- Heat Pump Vs an Air Conditioner
- Refrigeration and Heat Pump Cycle
- Function and Operation of Reversing Valve
- Operation of a Heat Pump in Heating and Cooling Mode
- Thermal Performance Terms
- Available Technologies

CHAPTER – 2: AIR SOURCE HEAT PUMPS (ASHP)

- How do Air to Air Heat Pumps Work
- How do Air to Water Heat Pumps Work
- Efficiency and COP of a Heat Pump
- Thermal Balance Point
- Sizing and Service Considerations
- Operating Costs and Payback
- Life Expectancy and Warranties

CHAPTER – 3: GROUND SOURCE HEAT PUMPS (GSHP)

- How do Ground Source Heat Pumps Work?
- Horizontal Loop V/s Vertical Loop Systems
- Series and Parallel Ground Loop Arrangements
- Sizing Considerations and Design Precautions
- Earth Loop Piping Materials and Working Fluids
- Suitability of Site, Commissioning and Decommissioning

CHAPTER – 4: WATER SOURCE HEAT PUMPS (WSHP)

- How do Water Source Heat Pumps Work?
- Open Loop and Closed Loop Systems
- Single Well, Standing Well and Double Well System
- Evaluating Open Loop Ground Water Feasibility
- Site requirements, Commissioning and Decommissioning
- Ground Water, Surface Water and Submerged Systems
- Pros and Cons

CHAPTER – 5: MAJOR COMPONENTS

- Compressors – Reciprocating, Screw, Scroll & Centrifugal
- Heat Exchangers – Condenser & Evaporator
- Receiver, Expansion Device & Refrigerants
- Portable Window Type Heat Pumps
- Ductless Mini-split Type Heat Pumps
- Ducted Split Heat Pumps
- Heated Floor Slab
- Radiant Panels, Panel Radiators & Fin based Baseboard

CHAPTER - 1

1. OVERVIEW OF HEAT PUMPS

Heat ALWAYS travels from high temperature to lower temperature.

A heat pump is a device that pumps heat from a lower temperature to a higher temperature. This is opposite to the natural flow of heat, but this applies for all refrigeration machines. However, the label 'heat pump' has evolved to define those refrigeration machines which can be configured to provide both cooling and heating, commonly referred to as "Reverse cycle".

1.1. Heat Pump Vs Air Conditioner

Simply put, both devices are the same except a heat pump can provide cooling in summer, as well as heating in winter using reversing cycle; whereas an air conditioner can only cool.

The air conditioners actually remove heat and moisture from the indoor space and transfer it to the air outdoors. This air enters the unit at 80°F and 50% relative humidity and after passing through the indoor coil, it leaves the unit at a temperature of 55°F and a relative humidity of 100%. The heat that has been transferred from this air is carried by a refrigerant (for example R134a) to the outdoor, or condenser coil. The moisture is condensed on the air conditioner evaporator's coil and is drained outside.

Obviously, outdoor ambient temperatures can be quite high during the periods when your space requires air conditioning. The refrigerant must transfer the heat it removed from the air in the indoor space to the outdoor air, but the outdoor air can be at a temperature of 95° F or more. Because we need to transfer this heat to air that is 95°F, the temperature of the refrigerant we are removing the heat from, must be substantially higher than the outdoor ambient temperature. The system is designed to blow outdoor air over tubes containing refrigerant at a temperature that is approximately 25°F warmer than the ambient air, so that the heat within the refrigerant can be transferred to the outdoor air.

The air conditioner is intended for removing heat from area of low temperature (for e.g. your room), and transferring it, or "pumping it" to an area of higher temperature (the air outside). The energy is required in pumping (compressor) because we are forcing heat to be transferred in a direction that is opposite to the way heat will flow naturally.

Technically, any air conditioner can be considered a heat pump, but the HVAC industry considers heat pumps, to be air conditioners that have the ability to operate with a “Reverse cycle”.

If you have walked behind a window air conditioner on a summer day, you might have felt the hot air being discharged by these machines. As described above, the temperature of the air leaving these units has increased because the refrigerant in the system picked up heat from the air inside the building, and that heat is being transferred to the air passing over the outdoor coil, thereby raising the temperature of the air.

Think about what would happen if you install the window air conditioner in reverse i.e. turning it 180°. Now, instead of transferring heat from inside the room to the outdoors, the air conditioner would be attempting to cool the great outdoors and transferring heat from the higher temperature outdoor air to the lower temperature air within the room. On a 95°F day this would be objectionable because we would end up with 125° temperatures inside the conditioned room. However, think about this process on a 45°F day. The air conditioning unit, installed backwards, would be removing heat from the outdoor air at 45°F and transferring it to the air within a room at 70°F. This heating process is called “Reverse cycle air conditioning,” and this is what a heat pump is designed to do. It is designed to cool a space when operating as an air conditioner and it is designed to heat a space when the cycle is reversed. The actual reversal of the cycle is accomplished by reversing the flow of refrigerant and causing the indoor coil and the outdoor coils to switch roles.

What is the Benefit?

The most important characteristic of a heat pump is that the amount of heat that can be transferred is greater than the energy needed to drive the cycle.

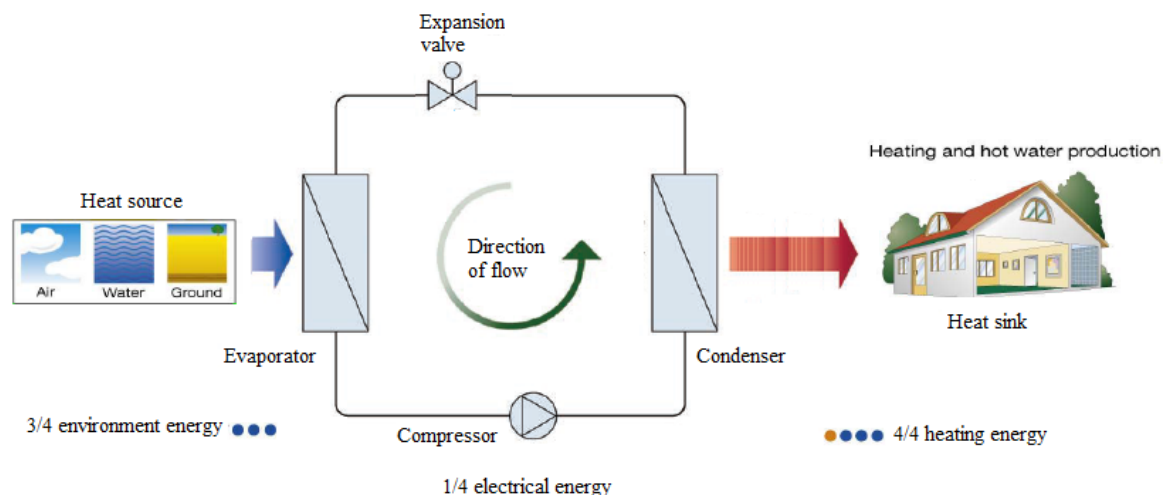

The key to the efficiency of a heat pump is the Coefficient of Performance: the “COP”.

In spite of the first law of thermodynamics, which tells us that energy can neither be created nor destroyed, the heat pump can yield up to four units of heat for each unit of electricity consumed. The heat pump is not creating this energy, but simply moves heat from cooler outdoor air into the warmer inside. Even in air that's seems too cold, heat energy is present. When it's cold outside, a heat pump extracts this outside heat and transfers it inside. When it's warm outside, it reverses directions and acts like an air conditioner, removing heat from your indoor space. It pushes heat in a direction counter to its normal flow (cold to hot, rather than hot to cold).

COP is determined by dividing the energy output of the heat pump by the electrical energy needed to run the heat pump, at a specific temperature.

Electrically driven heat pumps used for space heating applications in moderate climates usually have a COP of a least 3.5 at design conditions. This means that 3.5 kWh of heat is output for 1 kWh electricity used to drive the process. In simple terms, such a heat pump will be cheaper to operate provided that the electricity price is no more than 3.5 times the price of an alternative fuel. Irrespective, even when the operating costs for heat pumps and fuel fired boilers are rather similar, the case for heat pumps as a low carbon technology is more conclusive.

We will learn more about the key performance indicators in subsequent chapters.

1.2. Refrigeration Cycle

The refrigeration cycle is the basis of operation of all vapor-compression air conditioners and heat pumps. Although a detailed knowledge of thermodynamics is not required for the practical application of heat pumps, a basic understanding of the refrigeration concepts is important for all heating, ventilation and air conditioning (HVAC) system designers. Let's revisit the basic vapor compression refrigeration cycle first.

A simple vapor compression refrigeration cycle includes four major components: 1) compressor, 2) evaporator, 3) condenser and 4) expansion valve – all connected through a tube in closed circuit. It contains a refrigerant fluid that vaporizes and condenses inside the tubing as part of the operation process.

- The **compressor** is a pump that causes the refrigerant to circulate through the system. The compressor is rated to pump a set volume of vapor, so it will have a set capacity or BTU rating or Tonnage, depending on the refrigerant

being used, and the operating temperature in the evaporator. 1 ton of refrigeration is equivalent to 12000 BTU's/hour.

- The **evaporator** is a heat exchanger where the refrigerant vaporizes; i.e. it absorbs heat and the surroundings get cold.
- The **condenser** is a heat exchanger where the refrigerant condenses; i.e. it releases heat and the surroundings get hot.
- **Expansion valve** is a device used to reduce the pressure and temperature of the refrigerant at the end of the process cycle. Lowering the pressure of the refrigerant allows it to vaporize once heat is added.

The basic arrangement of a refrigeration circuit (cooling mode) is shown below:

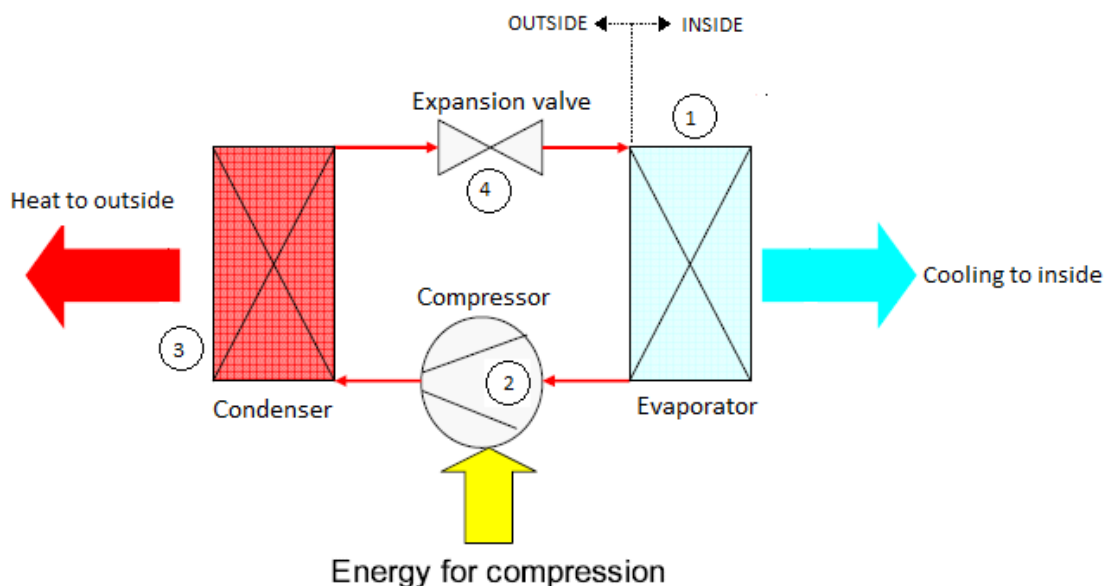

Let's see how this cycle works.

- Stage1
 - Refrigerant enters the evaporator in the form of a cool, low-pressure mixture of liquid and vapor. Heat is transferred from warm indoor air to the refrigerant; causing the liquid refrigerant to boil.
- Stage 2
 - The refrigerant vapor from the evaporator now enters the compressor, where its pressure (and hence temperature) is increased.

- Stage 3
 - The resulting hot, high-pressure refrigerant vapor enters the condenser where heat is transferred to ambient air or water. Inside the condenser, the refrigerant condenses into a liquid.
- Stage 4
 - This high pressure liquid refrigerant then flows from the condenser to the expansion device, which reduces its pressure. At this low pressure, a small portion of the refrigerant boils (or flashes), cooling the remaining liquid refrigerant to the desired evaporator temperature.

The cool mixture of liquid and vapor refrigerant repeats the cycle. The refrigeration cycle remains in continuous operation whenever the compressor is running. This cycle is used in refrigerators, freezers, room air conditioners, dehumidifiers, central air conditioning systems, water coolers, vending machines and other heat-moving machines.

1.3. Heat Pump Cycle

Heat pump uses the same principle of vapor compression refrigerant cycle and has the same basic components like a traditional air conditioner (compressor, condenser, evaporator, and expansion device), except that it can reverse the refrigeration cycle or in other words, swap the functions of the two heat exchangers (condenser and evaporator). Refer to the schematic below and note the application is reversed for heating mode. (Note the components are not reversed physically).

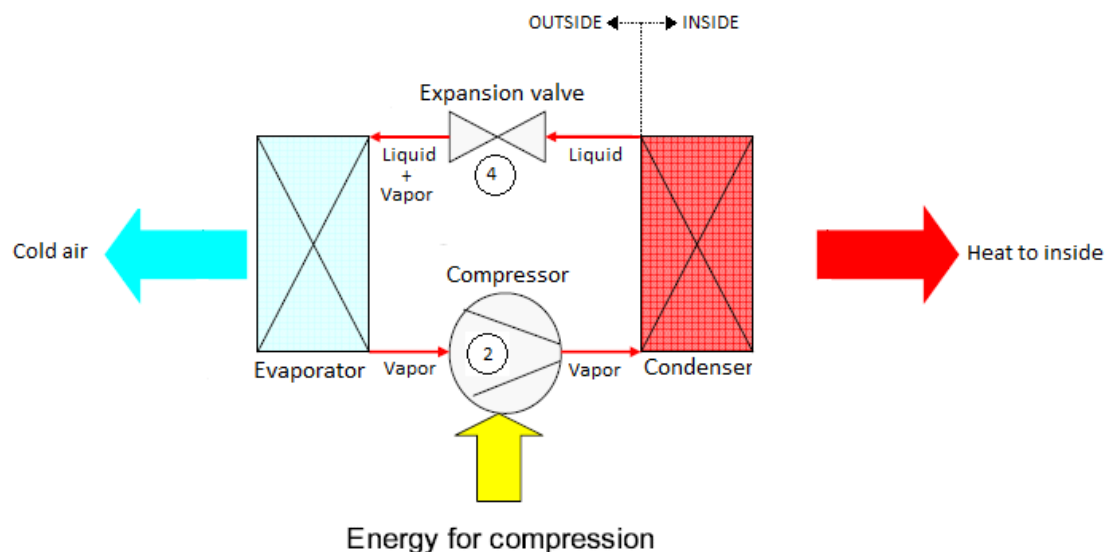

- Stage 1
 - Outside heat exchanger picks up heat from the earth, ground water or air and transfers it to the refrigerant. The refrigerant gets evaporated and now enters the compressor.
- Stage 2
 - The refrigerant, having now absorbed the environmental heat now enters the compressor and is compressed. The compressor increases the pressure of the refrigerant and also its heat content. This is the only part of the cycle where additional energy is required.
- Stage 3
 - The refrigerant gas now passes through the “indoor side” heat exchanger where it gives up its heat and turns back into a liquid.
- Stage 4
 - In order to be able to start the cycle again, the refrigerant must be de-pressurized, and so it is passed through an expansion valve, where it returns to a low-pressure liquid / gas mix and can begin to absorb heat from the air/earth/water again as it moves towards point 1.

1.4. Reversing Valve

The refrigeration cycle is reversed through a 4-way REVERSING VALVE.

The reversing valve is an electrically operated device that uses a solenoid coil to guide the direction of refrigerant flow. It regulates the refrigerant discharge ports to effectively “swap” the functions of the evaporator and condenser.



The reversing valve has four ports (A, B, C, and D):

- One port connected to the outlet of the compressor
- One port connected to the inlet of the compressor
- One port connected to one side of the indoor coil
- One port connected to one side of the outdoor coil

The reversing valve has an internal slide that ultimately determines the mode in which the system will operate. The reversing valve is typically located at the compressor outlet (discharge). If the system is a split-type system, this location is within the outdoor portion of the system.

Let's check its functionality and working principle.

1.5. Operation of a Heat Pump in Cooling Mode

The heat pump in cooling mode operates as a conventional air-conditioner with the indoor coil as an evaporator and the outdoor coil as a condenser.

The refrigerant (upon leaving the compressor via the red line in the figure below) first flows through the reversing valve where it is directed to the outdoor coil. Since the refrigerant always flows to the condenser first after leaving the compressor, the outdoor coil is acting as the condenser. In this mode of operation, the heat from the refrigerant is rejected to the outside air. From the outdoor coil, the refrigerant flows through the expansion device and then to the indoor coil, where the refrigerant picks up or absorbs heat from the air in the area being cooled. The refrigerant then flows back to the compressor via the reversing valve and the cycle repeats itself.

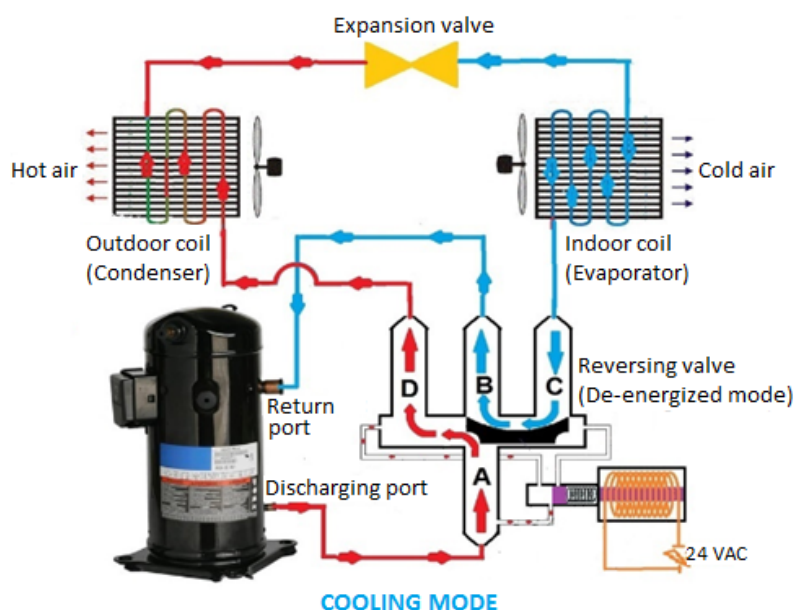

1.6. Operation of a Heat Pump in Heating Mode

In heating mode, the refrigerant (upon leaving the compressor via the red line in the figure below) first flows through the reversing valve where it is directed to the indoor coil. Since the refrigerant always flows to the condenser first after leaving the compressor, the indoor coil is acting as the condenser. In this mode of operation, the heat from the refrigerant is rejected to the air in the occupied space. From the indoor coil, the refrigerant flows through the expansion device and then to the outdoor coil, where the refrigerant picks up or absorbs heat from the outside air. The refrigerant then flows back to the compressor via the reversing valve and the cycle repeats itself.

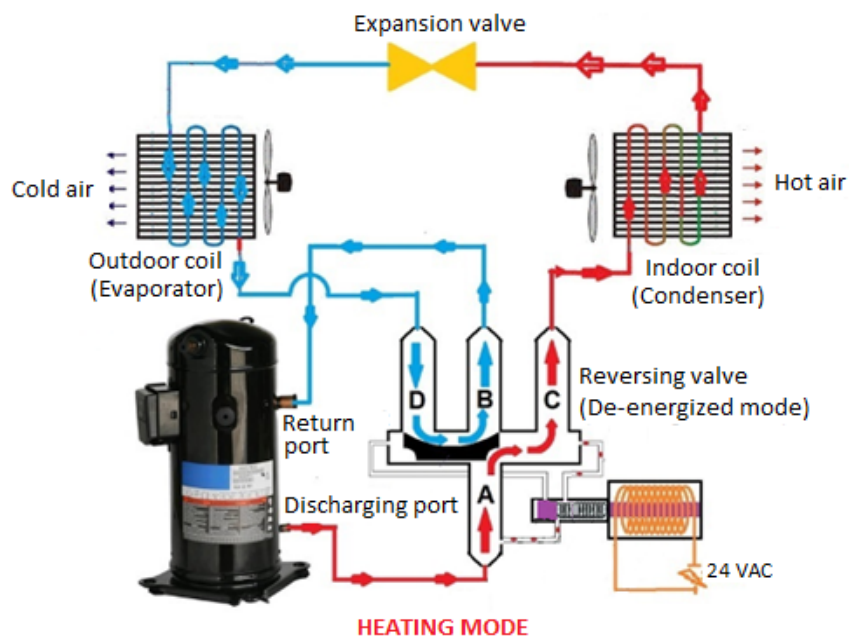

The outdoor coil of the heat pump will gather low-temperature heat from environment, where that heat is freely available and abundant (ground, water or air). The condenser side will always deliver higher temperature heat to the load.

Important

- The reversing valve is always installed at the discharge port (high pressure) of the compressor at tube “A” and the return port (low pressure is always connected to tube “B”. Therefore, tube A always has higher pressure refrigerant, and tube B always has lower pressure refrigerant.
- All reversing valves use an electromagnetic solenoid which requires 24VAC to energize. 99% of the reversing valve failures are due to bad or faulty electrical coil and not because the valve itself has failed. Replacing the

reversing valve could be a complicated process. It needs a very skilled person. If you really need to replace your valve, and your unit is over 10 years of age, please consider replacing the Heat Pump. The heat pump reversing valve might cost \$200-\$250.

- Note that the reversing valve is energized or de-energized based on the manufacturer's specification to direct the flow of refrigerant to the appropriate coils.

Do all heat pump systems have reversing valves?

No. Heat pumps that are intended to provide both heating and cooling are equipped with reversing valves. However, heat pump systems that are intended to provide only heating are not equipped with reversing valves.

1.7. Thermal Performance Terms

- **A Btu/h, or British thermal unit per hour**

- A Btu/h, or British thermal unit per hour, is a unit used to measure the heat output of a heating system.
 - ✓ One kWh of heat = 3414 Btu/h.
 - ✓ A ton is a measure of heat pump capacity. It is equivalent to 3.5 kW or 12 000 Btu/h.

- **Heating degree-days**

- Heating degree-days is a measure of the severity of the weather. One degree-day is counted for every degree that the average daily temperature is below the base temperature of 18°C. For example, if the average temperature on a particular day was 12°C, six degree-days would be credited to that day. The annual total is calculated by simply adding the daily totals.

- **The coefficient of performance (COP)**

- The performance of heat pumps is indicated by the coefficient of performance (COP). It measures the amount of heat energy moved (in watts), divided by the electric energy used to move it (also in watts), at a given outdoor temperature. Higher COP values indicate a more efficient system. An electric resistance

heater generating heat at 100% efficiency will have COP = 1, while a heat pump in heating mode ranges from a COP of 3 to 4.

- The COP of a heat pump is solely determined by the condensation temperature and the temperature lift (the difference between condensation and evaporation temperature) and is given by:

$$\text{COP} \propto \frac{T_{\text{cond}}}{(T_{\text{cond}} - T_{\text{evap}})}$$

Where temperatures are measured in Kelvin

- A basic rule for the design of an efficient heat pump systems is to minimize the temperature difference between the heat sink and the heat source to achieve maximum efficiency; for example, for a heating application use the warmest available heat source and lowest possible distribution temperature.
- **The heating seasonal performance factor (HSPF)**
 - The heating seasonal performance factor (HSPF) is a measure of the total heat output in Btu of a heat pump over the entire heating season divided by the total energy in watt hours it uses during that time. This number is similar to the seasonal efficiency of a fuel-fired heating system and includes energy for supplementary heating.
- **The energy efficiency ratio (EER)**
 - EER (energy efficiency ratio) is similar to COP, but only for cooling. It measures how efficiently a cooling system operates. The higher the EER, the more efficient the unit.
 - EER is most commonly applied to window units and smaller standalone air conditioners and heat pumps. The EER is the ratio of Btu/hr of cooling divided by the watts of electricity used at an outside temperature of 95°F (35°C). Room air conditioners should have an EER of at least 9.0 for mild climates and over 10.0 for hot climates.

- **The seasonal energy efficiency ratio (SEER)**
 - SEER (seasonal energy efficiency ratio) measures how efficiently a smaller residential air conditioner or heat pump operates over an entire cooling season, as opposed to a single outdoor temperature. As with EER, a higher SEER reflects a more efficient cooling system. SEER is the ratio of the total amount of cooling Btu's the system provides over the entire season divided by the total number of watt-hours it consumes. The SEER is based on a climate with an average summer temperature of 28°C.
- **The heating seasonal performance factor (HSPF)**
 - HSPF (heating seasonal performance factor) measures how efficiently heat pumps operate in heating mode over an entire heating season. It is like SEER but for heating. The higher the HSPF, the more efficient the system. HSPF is calculated by dividing the total number of Btu's of heat delivered over the heating season by the total number of watt-hours of electricity required to deliver that heat.
- **Thermal balance point**
 - The thermal balance point is the temperature at which the amount of heating provided by the heat pump equals the amount of heat lost from the building. At this point, the heat pump capacity matches the full heating needs of the building. Below this temperature, supplementary heat is required from another source.

1.8. Hot and Cold Source

The external medium from which heat is recovered is called a cold source. In the heat pump the refrigerant absorbs heat from the cold source by means of the evaporator. The cold source can be ambient air, earth, ground or surface water.

The medium to which the heat is transferred is called a hot source. In the heat pump, the refrigerant transfers both the heat drawn from the cold source and the heat energy supplied by the compressor to the hot source by means of the condenser. The hot source can be air or water.

1.9. Available Technologies

Heat pumps are classified based on the fluid used for the heat source while the heat pump is operating in the heating mode. For example, a heat pump that uses air as its heat source when operating in the heating mode is referred to as an air-source heat pump. Also, a heat pump system that uses earth or water as its heat source when operating in the heating mode is classified as a ground source or water-source heat pump respectively.

Two main types of heat pumps are:

1. Air Source heat pumps

- Heat is transferred from the low-temperature AIR outside to the high-temperature interior.

2. Geothermal heat pumps

- Ground source heat pump
 - Relies on the relative warmth of EARTH for its heating and cooling production. The earth is used as a heat sink in the summer and a heat source in the winter.
- Water source heat pump
 - Heat is transferred from low-temperature WATER outside (from a pond, lake or ground) to a high-temperature interior.

Air source heat pumps are further classified as:

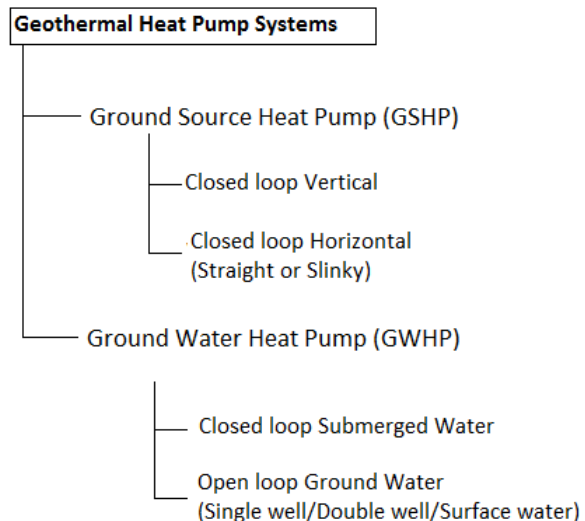
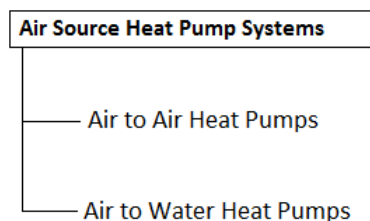

How these systems are adapted to building structures depends on the used application and source of energy. We will discuss the most common heat pump applications in next chapter.

CHAPTER – 2

2. AIR SOURCE HEAT PUMPS (ASHP)

An Air-source heat pump (ASHP) uses AIR as the heat source when the system is operating in the heating mode. We can use the heat in the air to heat air or water. Accordingly, there are two types of air-source heat pumps.

1. Air to Air heat pump
2. Air to Water heat pump

The first word in the category name is the source of heat. The word following “to” is the media that is being treated. This means that when we use the heat in the air to heat air, we call that heat pump an air-to-air heat pump. When we use the heat in the air to heat water, we call that heat pump an air-to-water heat pump.

2.1. Air to Air Heat Pumps

An air-to-air is used for comfort cooling and heating.

- In the winter, a heat pump extracts heat contained in the outdoor air and delivers it inside the occupied space.
- On hot summer days, it works in reverse, extracting heat from the occupied space and pumping it outdoors to cool the house.

Most of Air to Air heat pumps are so called split-system, meaning that the heat is absorbed at one place and released at another location. Split system consists of two heat transfer surfaces. One coil or heat transfer surface is located inside the structure, while the other is located outside the structure. These surfaces are referred to as the condenser and the evaporator. The evaporator absorbs heat, while the condenser is responsible for rejecting heat. The function of the heat transfer surfaces can be changed to produce the desired mode of system operation. So, the indoor and outdoor coils can function as either the condenser or the evaporator, depending on the mode it's operating in.

The schematic below shows the main components and the arrangement.

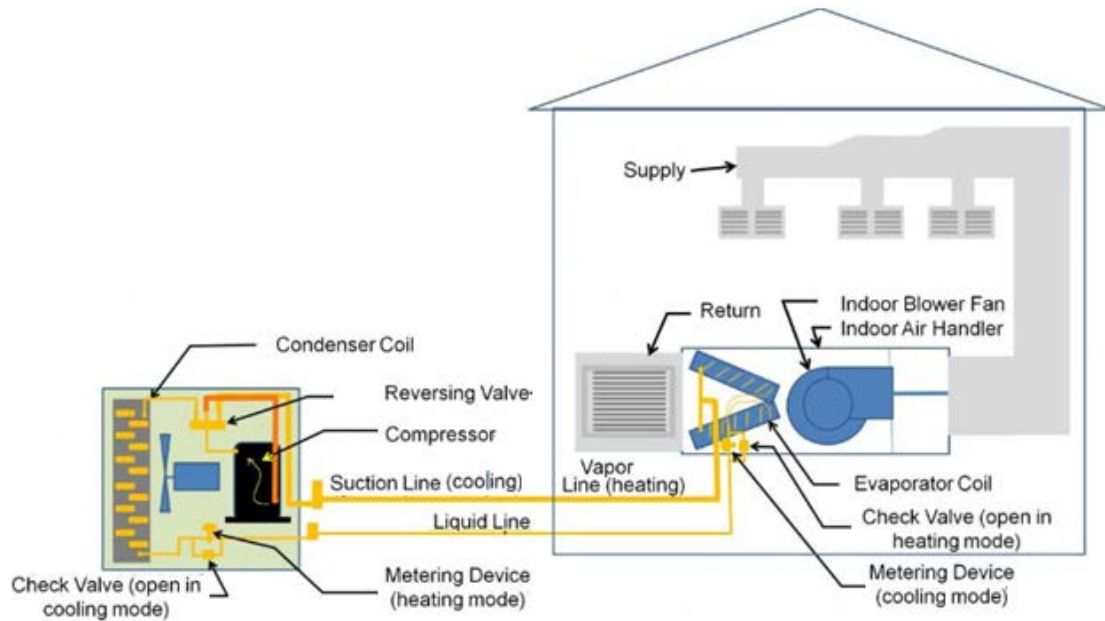

The indoor and outdoor units are inter-connected with tubing and a heat transfer medium, known as a refrigerant, which is circulated through the loop to facilitate the desired heat transfer. With a special 4-way reversing valve, the refrigerating cycle can be switched to the heating or cooling mode. During heating, the outdoor unit serves as an evaporator to extract heat from air; the indoor unit performs condensation, and blows hot air into the room. The reverse happens during summer cooling, i.e. the heat pump takes heat out of the indoor air and rejects it outside.

2.2. Heating Mode Operation

In the heating mode, the indoor coil functions as the condenser and the outdoor coil functions as the evaporator.

Refer to the schematic of Air to Air Heat Pump in the heating mode below:

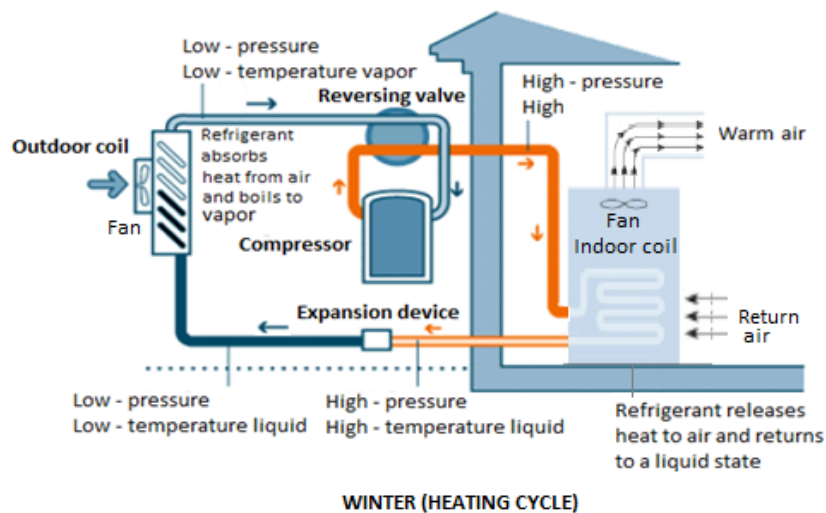

The outdoor unit fan draws air from open environment, which flows over the outdoor coil containing a refrigerant liquid. The liquid refrigerant absorbs the heat from the air and boils (evaporates) to vapor. The outside coil is thus referred to as Evaporator.

The refrigerant vapor is then compressed to higher temperature and pressure and is moved to the indoor coil. The refrigerant gives up its heat to the indoor air and condenses to liquid. Therefore, in the heating mode, the indoor coil is referred to as the Condenser Coil.

The refrigerant circulates in the equipment repeating the processes of compression, condensation, expansion and evaporation and back to compression in order to remove the warm air inside the room to the outdoor.

This process is automatically controlled by a thermostat until the required room temperature is reached. When extra heat is needed on particularly cold days, supplemental electric-resistance heater kicks on to add warmth to the air that is passing through.

Cooling Mode

The Air to Air heat pump will reverse to cooling mode in summer months when the outdoor air temperature is higher than the room temperature. In the cooling mode, the indoor coil functions as the evaporator and the outdoor coil functions as the condenser. Air from the occupied space passes over the evaporator, or cooling coil, and heat energy is transferred from the air to the coil. This heat is ultimately transferred to the outdoor coil, which is acting as the condenser. At the condenser, the heat is then rejected to the outside.

Refer to the schematic below for the cooling cycle.

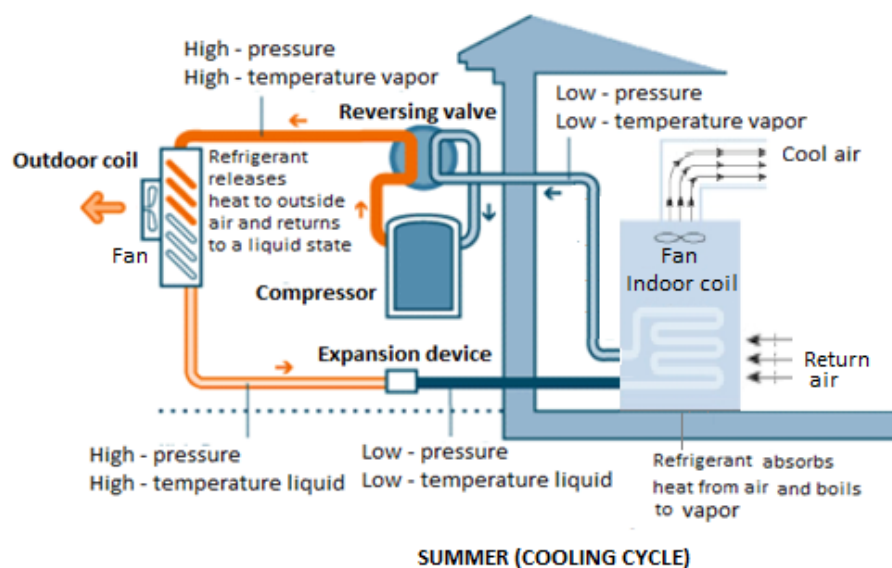

2.3. Heating Capacity

Normally, a heat pump is capable of delivering a maximum of about 1.25 times its cooling capacity as heating capacity. If it provides 100,000 BTUH of cooling, it will provide nearly 125,000 BTUH of heating at maximum capacity. However, maximum heating capacity occurs at 70°F outdoor temperatures, when we need it least.

The ability of the heat pump to transfer heat from the outside air to the inside depends on the outdoor temperature. As the outside air temperature drops, the ability of the heat pump to absorb heat also drops. The minimum outdoor temperature at which a heat pump can satisfy the heating requirements of a space without the use of auxiliary electric heat is defined as the “Balance point.” This balance point is determined by plotting the heating requirement of the space at different outdoor temperatures, the heating capacity of the heat pump, and the lowest outdoor ambient design temperature. The place where the space heating requirement and heat pump output lines cross is the balance point. For any temperature below the balance point, supplemental heat will be required.

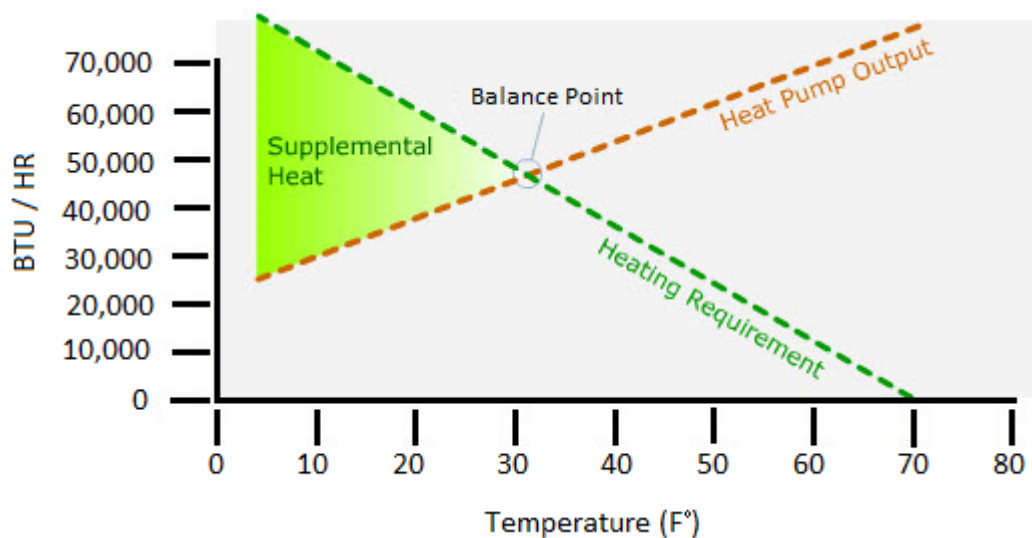

The supplementary heat can be supplied by an oil, gas or electric furnace or in the form of electric-resistance heaters. Supplementary heating is energized only when the space heating load cannot be met by the capacity of the heat pump. ASHRAE/IESNA Standard 90.1-1999 stipulates heat pumps equipped with internal electrical resistance heaters shall have controls to prevent supplemental heater operation when the heating load can be met by the heat pump alone during heating or setback recovery.

2.4. Air to Water Heat Pumps

Air to Water heat pumps take heat from air outside the property and transfer this to water that can be used for space heating or as hot water for taps, showers, washing or laundry services within the house.

The criteria by which heat is transferred can be simplified by way of the schematic shown for space conditioning system:

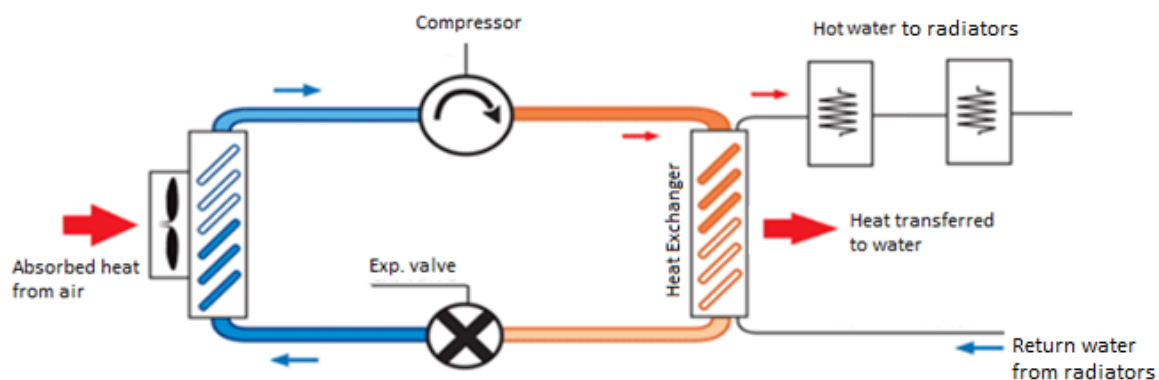

The air source heat pump does not produce the sort of hot water temperature you would associate with a gas, LPG or oil powered boiler. With a boiler, you would expect the hot water to be heated to about 185°F (85°C), while a heat pump produces water to about 130°F (~55°C). This means, greater volume of water will be needed to satisfy the heating requirements.

2.4.1. How Do Air to Water Heat Pumps Work?

The system is comprised of 2 parts: an indoor unit and an outdoor unit (which can be installed at distances in excess of 50 meters from the indoor unit). A third component, a hot water storage tank, is connected to the indoor unit.

Heated water up to 130°F (~55°C) may either be used to supply direct hot water to taps/showers and/or to be routed around a low-temperature central heating network; under floor, radiator or a combination of the two.

Application 1

This installation is for supplying hot water only. The installation utilizes an expansion tank to keep the pressure inside the hot water system.

Auto air releasing valve helps to release air inside the water system automatically.

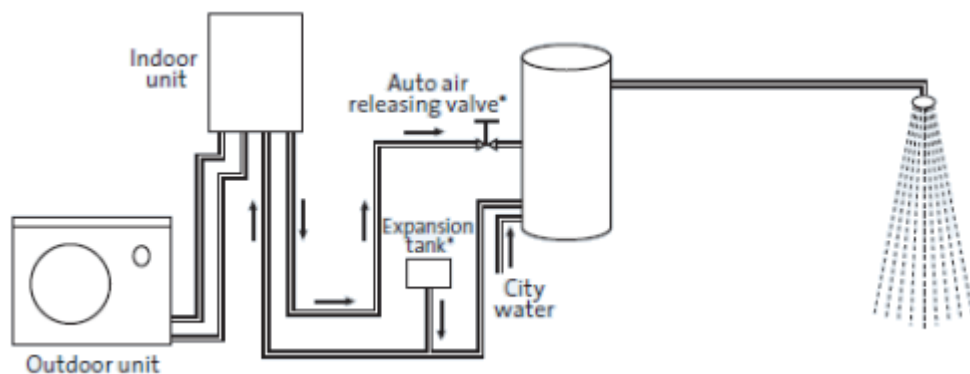

Application 2

More advanced designs of air-source heat pumps can provide domestic hot water and space heating at the same time. The domestic hot water (DHW) is normally heated through some kind of heat exchanger allowing heat to be transferred from the heating water into the DHW. One way of doing this is to use a “tank in tank” – see the schematic below. Here the DHW tank is surrounded by the space heating water and therefore absorbs heat from the space heating water through the walls of the inner tank.

The buffer tank is also provided to keep proper water volume inside the water system and to maintain water temperature at a constant level. It is sized at least 10% of minimum heating water volume flow rate required through the heat pump. A buffer tank is absolutely essential for air to water heat pumps to:

- To allow the defrost cycle to happen
- To allow supplementary heating
- To improve the economy and efficiency of the system

The return water is replaced with the fresh makeup city water.

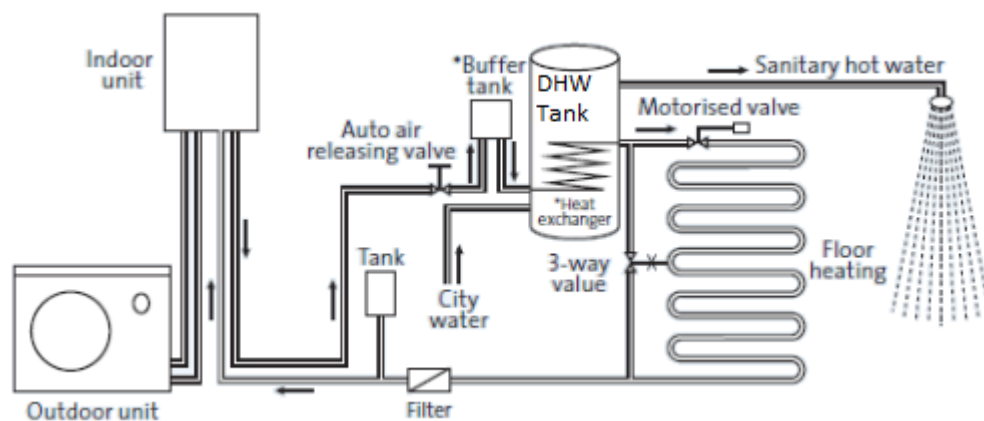

In colder climates, an antifreeze solution is circulated between the outside unit and indoor load. This reduces the risk of freezing during a power outage or if the heat pump becomes inoperable during cold weather. The antifreeze solution can be directly circulated through the indoor distribution system or separated from a water-based hydronic distribution system using a heat exchanger, as shown in the Figure below.

Unlike Air-to-Air heat pumps, most Air-to-Water heat pumps are also used for dedicated heating applications. Theoretically, they are capable of producing chilled water for building cooling or other processes requiring chilled water, but they are not an economical choice.

Do all heat pumps require a reversing valve?

No, not all the heat pumps require 4-port reversing valve.

The heat pump systems that are intended to provide only heating are not equipped with reversing valves. For example, the heat pump for swimming pool heater does not use a reversing valve. The sole purpose of the heat pump pool heater is to heat the water in the swimming pool. This heat pump is never used to cool the pool water, so there is no need for the system to operate in both the heating and cooling mode.

Important

Only the heat pumps that are intended to provide both heating and cooling are equipped with reversing valves.

Word of caution

Most small domestic heat pumps are able to supply water at relatively low temperatures of around 130°F (~55°C) maximum. For safety against Legionella disease caused by bug or bacteria in stagnant water, the domestic hot water temperature be over 60°C intermittently. At this temperature the bacteria dies within two minutes and at an even faster rate at higher temperatures. Most installers will arrange for the DHW to be heated once a day to above 60°C, usually by an immersion heater on a timer.

2.5. Efficiency of a Heat Pump

Efficiency of a heat pump is measured using a term “Coefficient of Performance” aka (COP), and it is the ratio of the useful heat that is pumped to a higher temperature to a unit amount of work that is put in. We will look at COP in terms of air-source heat pumps.

A general expression for the efficiency of a heat engine can be written as:

$$\text{COP} = \frac{\text{Heat Energy}_{\text{hot}}}{\text{Work}}$$

Using the same logic that was used for heat engines, this expression becomes:

$$\text{COP} = \frac{Q_{\text{hot}}}{Q_{\text{hot}} - Q_{\text{cold}}}$$

Where,

Q_{hot} = Heat input at high temperature and

Q_{cold} = Heat rejected at low temperature.

The expression can be rewritten as:

$$\text{COP} = \frac{T_{\text{hot}}}{T_{\text{hot}} - T_{\text{cold}}}$$

Note: T_{hot} and T_{cold} must be expressed in the Kelvin scale.

Example 1

Calculate the ideal coefficient of performance (COP) for an air-to-air heat pump used to maintain the temperature of a house at 70°F when the outside temperature is 30°F.

Solution:

First, convert the Fahrenheit temperatures to Celsius temperatures using this formula:

$$T_{\text{hot}} = (70-32) \times 5 / 9 = 21^{\circ}\text{C}$$

$$T_{\text{cold}} = (30-32) \times 5 / 9 = -1^{\circ}\text{C}$$

Next, convert the Celsius temperatures to Kelvin temperatures by adding 273.

$$T_{\text{hot}} = 21^{\circ}\text{C} + 273 = 294\text{K}$$

$$T_{\text{cold}} = -1^{\circ}\text{C} + 273 = 272\text{K}$$

Finally, use the formula from the previous screen to solve for the COP.

$$\text{COP} = \frac{T_{\text{hot}}}{T_{\text{hot}} - T_{\text{cold}}}$$

$$\text{COP} = 294\text{K} / (294\text{K} - 272\text{K}) = 294 / 22 = 13.3$$

The example above shows that for every watt of power we use (and pay for) to drive this ideal heat pump, 13.3 W is delivered to the interior of the house and 12.3 from the outside (we don't pay for this). This seems to be a deal that one cannot refuse. However, the theoretical maximum is never achieved in the real world. In practice, a COP in the range of 3 to 4 is typical. Even with this range, it is an excellent choice, because for every watt of power that we use, we transfer 2 to 3 additional watts from outside. What this means is that they will always cost less to operate than electric resistance heat. If it cost \$30 per week to heat a space with electric resistance heat, it would cost \$10 per week to heat the space with a heat pump.

Unfortunately, this coefficient of performance varies with the outdoor temperature. This makes sense when you think about it, because it is going to be a lot easier to remove heat from 50°F outdoor air than it is to remove heat from 10°F outdoor air. Let's check this with an example.

Example 2

Compare the ideal coefficients of performance of the same heat pump installed in two different locations with average outdoor temperatures of 40°F and 15°F respectively. Assume the inside temperatures in both the cases are maintained at 70°F.

Location #1

$$T_{\text{hot}} = (70-32) \times 5 / 9 = 21^{\circ}\text{C}$$

$$T_{\text{cold}} = (40-32) \times 5 / 9 = 4^{\circ}\text{C}$$

Next, convert the Celsius temperatures to Kelvin temperatures by adding 273.

$$T_{\text{hot}} = 21^{\circ}\text{C} + 273 = 294\text{K}$$

$$T_{\text{cold}} = 4^{\circ}\text{C} + 273 = 277\text{K}$$

Finally, use the formula to solve for the COP.

$$\text{COP} = \frac{T_{\text{hot}}}{T_{\text{hot}} - T_{\text{cold}}}$$

$$\text{COP} = 294\text{K} / (294\text{K} - 277\text{K}) = 294 / 17 = 17.3$$

Location #2

$$T_{\text{hot}} = (70-32) \times 5 / 9 = 21^{\circ}\text{C}$$

$$T_{\text{cold}} = (15-32) \times 5 / 9 = -9.4^{\circ}\text{C}$$

Next, convert the Celsius temperatures to Kelvin temperatures by adding 273.

$$T_{\text{hot}} = 21^{\circ}\text{C} + 273 = 294\text{K}$$

$$T_{\text{cold}} = -9.4^{\circ}\text{C} + 273 = 263.6\text{K}$$

Finally, use the formula to solve for the COP.

$$\text{COP} = \frac{T_{\text{hot}}}{T_{\text{hot}} - T_{\text{cold}}}$$

$$\text{COP} = 294\text{K} / (294\text{K} - 264\text{K}) = 294 / 30.4 = 9.7$$

The example shows the COP decreases on the cold days because it is much more difficult to extract heat from cooler air.

If the temperature in your area regularly drops below freezing, a heat pump is not a good idea. For all the places where climates are relatively mild year round, heat pumps may be applied well. Think of the heating requirements in cities like Orlando, San Francisco, and Houston. Very rarely do temperatures drop below 50°F, so capacity and efficiency of heat pump systems will remain high.

2.5.1. Heating Season Performance Factor (HSPF)

The other term for heat pump efficiency in heating cycle is Heating Season Performance Factor (HSPF). It is the ratio of heat provided in Btu per hour to watts of energy used. This factor considers the losses when the equipment starts up and stops, as well as the energy lost during the defrost cycle. New heat pumps manufactured after 2005 are required to have an HSPF of at least 7.7. Typical values for the HSPF are 7.7 for minimum efficiency, 8.0 for medium efficiency, and 8.2 for high efficiency. Variable speed heat pumps have HSPF ratings as high as 9.0, and geothermal heat pumps have HSPFs over 10.0. The HSPF averages the performance of heating equipment for a typical winter in the United States, so the actual efficiency will vary in different climates. In colder climates, the HSPF declines and in warmer climates, it increases.

2.6. Sizing Considerations

While a heat pump can be sized to provide most of the heat required by an indoor space, this is not generally a good idea. In cold places, heating loads are larger than cooling loads. If the heat pump is sized to match the heating load, it will be too large for the cooling requirement, and will operate only intermittently in the cooling mode.

This may reduce performance and the unit's ability to provide dehumidification in the summer.

Also, as the outdoor air temperature drops, so does the efficiency of an air-source heat pump. Consequently, it doesn't make economic sense to try to meet all your heating needs with an air-source heat pump.

As a rule, an air-source heat pump should be sized to provide no more than 125 percent of the cooling load. A heat pump selected in this manner would meet about 80 to 90% of the annual heating load, depending on climate zone, and would have a balance point between 0°C and -5°C. This generally results in the best combination of cost and seasonal performance.

2.7. Technology Advancements

In cold climate areas, air-source heat pumps which utilize ambient heat are less efficient than those in warmer areas. In the past, when the heat pump technology was not so advanced as today, the heating performance of some pieces of heat pump equipment drastically declined when the outside air temperature became low.

Therefore, air-source heat pumps were rarely introduced for heating purposes, while fossil fuel combustion boilers were mainly used under such cold climate.

However, the performance of air-source heat pumps has been remarkably improved in recent years, and some products newly born have sufficient heating performance even at an outside air temperature of -25°C due to the enhanced performance of compressors and heat exchangers. For example, an air-source heat pump water heating system for residential use that was invented by Daikin Industries, Ltd. in 2006 and Mitsubishi Electric Corp. in 2009 can supply sufficient heat in a climate below freezing point, and achieve a level of COP 3 at an outside air temperature of -10°C.

2.8. Operating Costs and Payback

The energy costs of a heat pump can be lower than those of other heating systems, particularly electric or oil heating systems.

However, the relative savings will depend on whether you are currently using electricity, oil, propane or natural gas, and on the relative costs of different energy sources in your area. By running a heat pump, you will use less gas or oil, but more electricity. If you live in an area where electricity is expensive, your operating costs may be higher. Depending on these factors, the payback period for investment in an

air-source heat pump rather than a central air conditioner could be anywhere from two to seven years.

2.9. Life Expectancy and Warranties

Air-source heat pumps have a service life of between 15 and 20 years. The compressor is the critical component of the system.

Most heat pumps are covered by a one-year warranty on parts and labor, and an additional five- to ten-year warranty on the compressor (for parts only). However, warranties vary between manufacturers, so check the fine print.

2.10. Service Considerations

There are a few things that must be considered when dealing with heat pumps from a maintenance and service standpoint. The first item to consider is the fact that the compressor in a heat pump system may see considerably more hours of use than the air conditioning unit with electric resistance heater or furnace with gas heat. This makes perfect sense since we are using the compressor in both heating and cooling modes. Compressors in heat pumps are also forced to operate over a much greater variety of conditions. This requires the installation of several additional components and acts to shorten compressor life.

2.10.1. Defrost

During heating operation, at low outdoor temperatures, frost forms on the outdoor coils. If the frost was allowed to build up to the point where the coil gets completely blocked, the unit's capacity would be severely diminished and the compressor could be damaged due to liquid slugging. Therefore, heat pumps have to be equipped with controls that monitor and detect when the outdoor coil becomes iced over and put the unit into a defrost cycle. These controls then have to determine when the coil has been defrosted and terminate the defrost cycle. The figure below shows what can happen if the defrost cycle does not run.



The defrost cycle can be managed with the unit's own refrigeration cycle. Here, the reversing valve switches the device to the cooling mode. This sends hot gas to the outdoor coil to melt the frost. At the same time the outdoor fan, which normally blows cold air over the coil, is shut off in order to reduce the amount of heat needed to melt the frost. While this is happening, the heat pump is cooling the air in the ductwork.

Demand-frost controls monitor airflow, refrigerant pressure, and air/coil temperature and pressure differential across the outdoor coil to detect frost accumulation on the outdoor coil. The number of defrosting operations is influenced by the climate, air/coil design, and the hours of operation. It was found that little defrosting is required when outdoor air conditions are below 42°F (~5.5°C) and 60% RH (confirmed by psychrometric analysis). Under very humid conditions, when small suspended water droplets are present in the air, the rate of frost deposit may be about three times as great as predicted from psychrometric analysis. The heat pump may require defrosting after only 20 min of operation. The loss of available heating capacity due to frosting should be taken into account when sizing an air source heat pump.

2.10.2. Accumulator

Heat pumps also use a device called a suction accumulator that is not normally found in other air conditioning units. The accumulator is actually a tank that is installed just before the compressor in the suction line. The purpose of this device is to allow any liquid that finds its way to the compressor to flash off into vapor prior to entering the compressor. The accumulator also provides a way for oil that is mixed with the liquid refrigerant to be returned to the compressor.

2.10.3. Liquid Line Drier

The nature of heat pumps dictates that some of the refrigerant piping serves a dual purpose. The refrigerant flow in the liquid line of a heat pump actually changes direction. Most air conditioning systems have a liquid line drier mounted in this piping. Heat pumps also have a drier mounted in the liquid line, but it must be of a bi-flow type so that it filters refrigerant flowing in both directions. When the refrigerant piping is fabricated and installed on a split system air conditioner, there are certain procedures that are followed to ensure good oil return to the compressor. These include installation of oil traps and correct pitching of piping as well as the installation of double risers. The fact that heat pumps use the refrigerant piping for different purposes during heating and cooling operations prevents the installer from following these procedures. For this reason, split system heat pumps must be applied and piped strictly according to the equipment manufacturer's recommendations.

2.10.4. Reversible Valve

Heat pumps use an electrically operated valve to switch refrigerant flow. There are currently three different variations of control wiring for heat pumps. These are based upon how the reversing valve is to be controlled. Some manufacturers set up a unit so that it is in the heating mode when the valve is energized. Some manufacturers energize the valve when the unit is in cooling mode. Some manufacturers have the thermostat control the valve operation through the use of an additional control wire and other manufacturers set up their control wiring the same as the standard wiring for a non-heat pump unit. In addition, there are several different control requirements that are dependent on the way electric heaters are to be controlled. As equipment becomes more complex it becomes more expensive to service. This is due to the fact that there are more components to fail and fewer technicians who are capable of diagnosing and making repairs easily.

Summarizing....

Compared with other alternatives, ASHPs have the following advantages:

- Provide central cooling, heating and hot water.
- Simplicity of design and ease of installation and operation.
- Compact system and can be easily retrofitted in existing buildings equipped with a conventional heating system.

- Cheaper to install and the shortest payoff period compared to other types of heat pumps.
- Energy efficient – heat output is 3 to 4 times the energy input.
- Compact and quiet system.

The disadvantage is the significant efficiency drops in cold weather. The delivered capacity of a heat pump will be at its lowest temperature when space heating is needed most. Therefore, an ASHP must have an alternate supplemental heating device to overcome the capacity shortfall, but generally, if the outside temperature regularly drops below freezing where you live, heat pumps are not a good idea.

It is less common to use ASHPs to provide domestic hot water due to the higher temperature gap between the heat source (air) and the need to keep hot water above 60°C. This may require a supplementary form of heating to reach the necessary temperature levels.

CHAPTER – 3

3. GROUND SOURCE HEAT PUMPS (GSHP)

In the previous chapter, we discussed the Air Source Heat Pumps (ASHP's) that transfer heat between outdoor air and indoor air. What if we replaced the outdoor air with ground or never ending flow of water at a temperature between 75°F and 80°F?

Ground-source or geothermal heat pumps (GSHPs) use the ground as the heat sink in the summer and heat source in the winter instead of outdoor air. These rely on the relative warmth of the earth for their heating and cooling production. Like ASHP, the GSHPs do not create heat; they simply move it from one area to another.

3.1. Operating Principle

In this application, the underground pipe containing some fluid is pumped through long lengths of piping buried in the ground. The fluid is water or a mixture of water and antifreeze (for example glycol, brine etc.). The flowing fluid exchanges its heat with the earth and transfers it indoors. The transfer of heat from and to the piping is passive in that no external energy is required to heat and cool the loop water. Only a small circulation pump is needed to circulate the fluid in a closed loop.

This type of system is advantageous because the ground temperature below the frost line remains both stable and warmer in winter than the outdoor air temperature. It is much easier to extract heat from 80°F water than 30°F cold outside air. Thus the capacity and efficiency of an Ground Source Heat Pump (GSHP) is not compromised during cold outside temperatures, which was the major limitation of Air Source Heat Pumps (ASHP).

The pipes that make up the ground heat exchanger can be oriented in a vertical, horizontal, or spiral pattern. Any of these patterns can be designed to provide the same fluid temperatures under a given set of conditions. The choice depends on available land, soil conditions, and excavation costs.

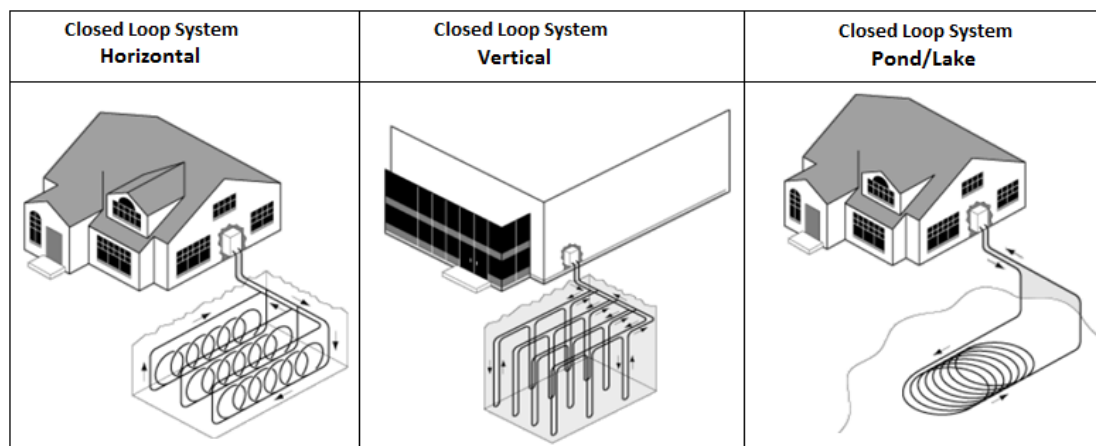

The characteristics and the configurations of the Ground Source Heat Pump system are discussed below.

3.2. Vertical Loop Systems

Vertical loops of high density polyethylene (HDPE) or cross linked polythene (PEX) pipes run a bore hole which can be 200 to 500 ft. (~60 to 150 m) deep.

The vertical bore holes are usually 4 to 8 in. (~10 to 20 cm) diameter, each arranged approximately 10 ft. (~3 m) apart.

The pipework is usually $\frac{3}{4}$ - $1\frac{1}{2}$ " (~20 – 40mm) diameter.

As a rule of thumb, vertical loops require roughly 125 to 150 ft. (~38 to 45 m) of borehole and anywhere from 250 to 300 ft² of ground surface per ton (~3.5 kW) of cooling.

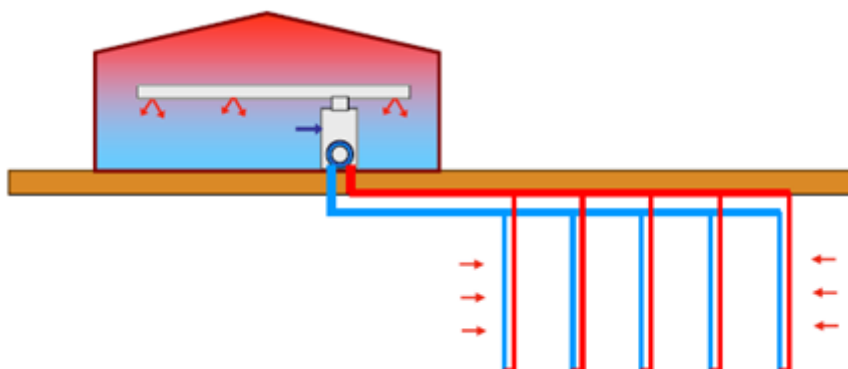

3.3. Installation

Installation methods for vertical looping include:

- Hammer drilling
- Rotary drilling
- Down-hole motor drilling.

The method chosen will depend on site characteristics, available drilling rig and budget. Vertical installations may require resource consent from the EPA or local regulation authorities for drilling activities.

Once the required number of holes is drilled, two HDPE or PEX pipes are fed down each bore hole. The bottom ends of these pipes are fusion welded together with a U-bend to close the circulation loop. The top ends of the pipes (supply and return) are “headered” so that all the U-tube assemblies operate in parallel (e.g., one side of each U-tube assembly is connected to a supply header, while the other side is connected to a return header). The headers are typically configured for reverse return flow with stepped piping sizes to maintain approximately the same head loss per unit length. This helps ensure equal flow distribution through each U-tube assembly.

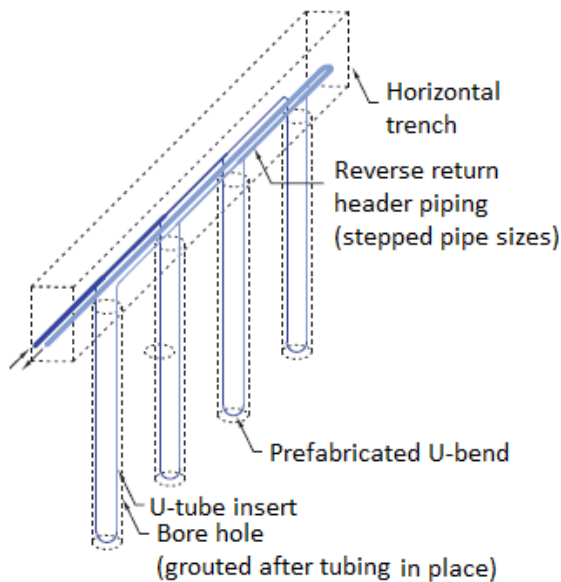

All earth loops, especially those with buried (inaccessible) fusion joints, should be pressure tested with compressed air to at least 75 psi for at least 24 hours to ensure there are absolutely no leaks.

Backfill and Grouts

After testing, each bore hole is carefully backfilled with grout slurry (bentonite) or thermally enhanced, low permeability clay mixed with a fine aggregate such as sand. The grouting fills any air voids around the tubing and earth and plays a major part in maximizing the conductive heat transfer. Grouting also seals the borehole off from surface water penetration. Standard grout actually has a poor conductivity, so the

borehole diameter should be minimized (to approximately 5" diameter) to limit the grout's effect. Some state and local governments have specific requirements for grouting boreholes to protect the integrity of ground water. Be sure to verify and comply with any such local requirements.

The two most common borehole heat exchanger designs are U-pipes and coaxial (concentric) pipes.

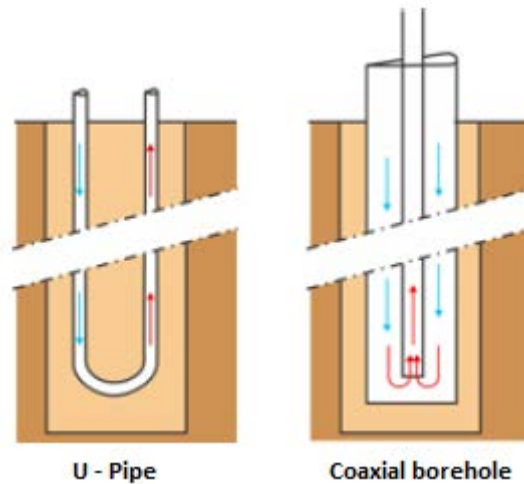

3.4. Horizontal Loop Systems

A horizontal loop runs piping parallel and close to the surface. The pipes are laid in shallow trenches and a working fluid is circulated through the network of pipes and provides the medium for heat transfer from the ground.

Horizontal loops are easier to install but require significantly more area (approximately 2500 ft²/ton).

The pipes are located typically 6 ft. (1.8 m) deep and spaced 6 to 15 ft. (1.8 to 4.6 m) apart.

The pipe material is usually high density polyethylene (HDPE) and is usually $\frac{3}{4}$ - $1\frac{1}{2}$ " (~20 – 40mm) diameter.

As a thumb rule, horizontal loops can range from 100 to 400 ft. of trench length per ton of cooling. Heat extraction rates are generally influenced by soil properties and other factors.

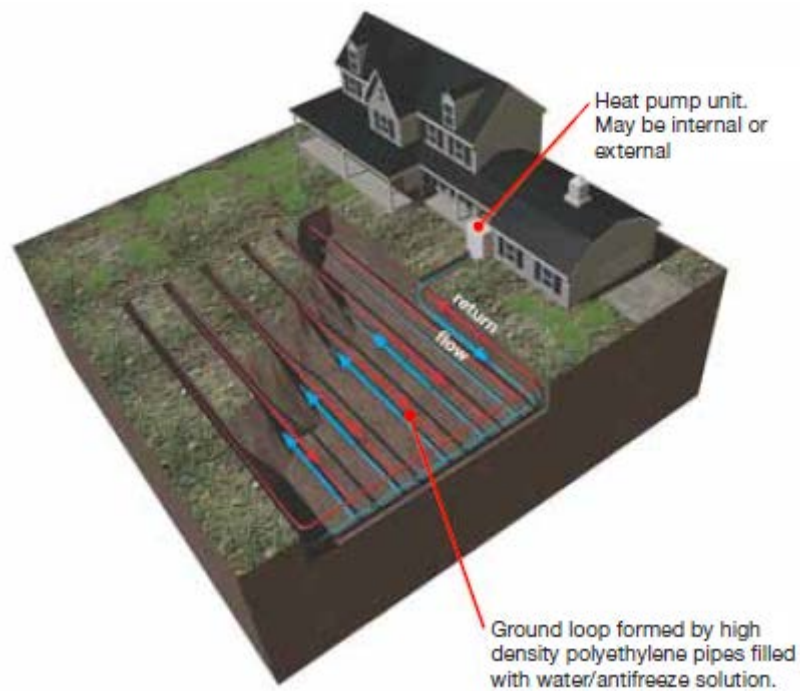

Horizontal loop system can be configured as straight, multiple or slinky arrangement.

Single pipe ground loops are installed over relatively large open areas, free from hard rock or large boulders with sufficient soil depth.

In an alternative arrangement, the single pipe can be doubled or quadrupled in multiple-layers. Multiple pipes placed close to each other are not as effective at gathering surrounding heat as are single tubes placed several feet apart. However, multiple pipes within a single trench can greatly reduce the amount of trenching required, and they often require more length of piping compared to a single layer loop.

A variation of the multiple-layer horizontal loop is the coiled loop; generally called a 'slinky' collector. This loop can be placed either vertically in a trench or horizontally in an open pit. The spiral loop generally requires more total piping, typically 500 to 1,000 ft. per cooling ton, but less trenching than multiple-layer, horizontal loops.

Horizontal earth loops will experience greater temperature variation between fall and spring compared to vertical earth loops. This allows the heat pump to achieve relatively high heating capacity and COPs in fall. However, both of these performance indices will decrease as winter progresses, and tend to be at or close to minimum in late winter or early spring.

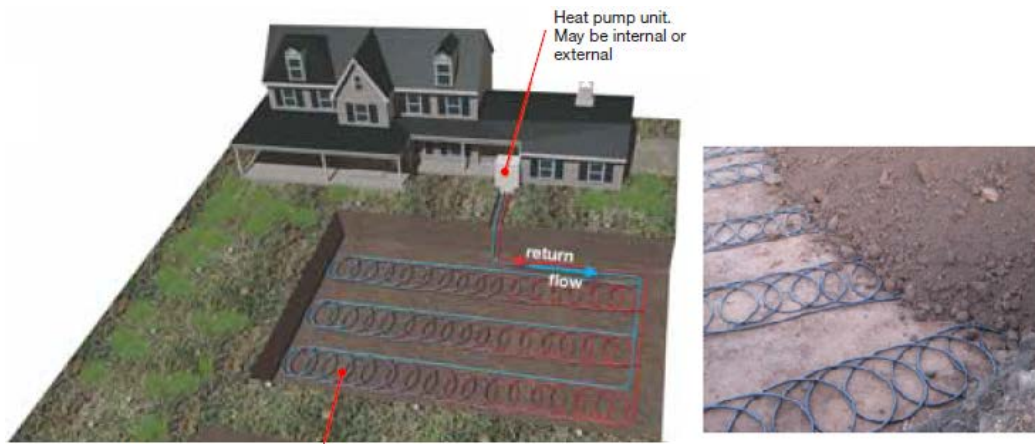

Alternative configuration to a standard straight pipe system. Coiled pipes allow access to more heat energy from a smaller area, however may require more pump energy to circulate the water/solution.

3.5. Installation

Installation methods for horizontal looping include:

- Stripping (i.e. laying pipes and backfilling)
- Trenching (i.e. laying pipes and backfilling)
- Direct placing of pipes with ploughs.

The method chosen will depend on site characteristics, budget and local regulatory requirements. Different methods will generate different site effects and may trigger consent requirements from local regulation authorities.

Backfilling

Earth loops should be carefully backfilled to avoid air gaps around tubing, as well as damage to tubing due to large or sharp rocks. If such rocks are present, the tubing should be “bedded” in a layer of fine soil or sand to protect it against damage during backfill.

The ground loop should be pressure tested prior to the backfilling. It should also be flushed and purged of air before being charged with the working fluid.

3.6. Horizontal Looping V/s Vertical Looping

Horizontal Looping	Vertical Looping
Horizontal loops require a larger land area, which can be a restricting factor. Normally, several hundred feet of ground need to be excavated.	Vertical ground loops require smaller space (less land) for installation.

<p>Requires longer pipes because the ground temperatures are subject to seasonal temperature variations, rainfall, and snow melting. Obtaining the same system efficiency as the vertical loop requires a more complicated design with longer pipe lengths.</p> <p>The longer pipe lengths also require more antifreeze solution, when necessary.</p> <p>The pipe is at greater risk of damage during backfilling of the trenches.</p>	<p>Because of relatively minor variations in deep soil temperature, heat pumps supplied from vertical earth loops will require less piping and provide relatively consistent heating and cooling capacity.</p>
<p>Trenching costs are typically lower than the drilling costs associated with vertical loop installation. The costs will be lower particularly if undertaken during earthworks for the construction of a new building where earthmoving equipment is already on site.</p>	<p>Drilling costs are frequently higher than the trenching costs associated with horizontal and spiral loops. A good access is required to get the drilling rig onto the site.</p>
<p>They may not build up as much heat over time because the pipes are closer to the surface, where heat can be dissipated to the atmosphere. This may also make it a good application for melting ice in parking lots.</p>	<p>Backfilling of the bore holes requires special attention to fill material and to ensure that the pipes and earth remain in contact. If the bore holes are spaced too close together, there is a potential for long-term heat buildup in the ground that may be undesirable.</p>
<p>Unless data is available from geological survey in the immediate area, a geologist survey is recommended prior to project commencement.</p>	<p>Unless data is available from geological survey in the immediate area, a test hole and/or a geologist survey is recommended prior to project commencement.</p>

3.7. Ground Loop Arrangements (series or parallel)

Vertical and horizontal loops can be arranged in series, in parallel or a combination of both.

The figure below shows both series and parallel installations.

- A series flow only has one path for the fluid to flow along. A benefit is that it is easier to remove air that is trapped in the plastic pipe.
- In parallel systems, the fluid can take two or more paths through the circuit. A benefit of parallel is that a small diameter pipe can be used due to lower pressure drops and save money on installation.

Parallel arrangements use a reverse return rather than direct return to the building so that all parallel flow paths are of equal length, helping to ensure a balanced flow distribution. Parallel loops are most common with series loops typically only being suitable for small applications.

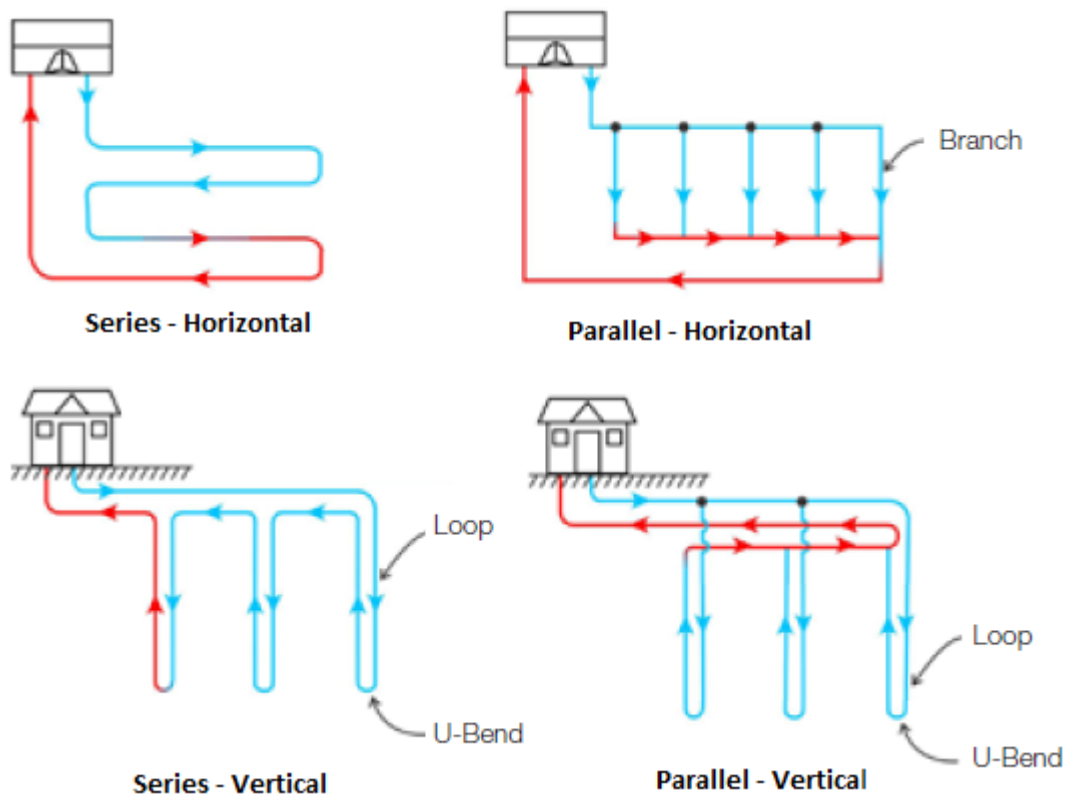

The type of arrangement will influence the pipe diameter, pump power requirements and installation cost. Advantages and disadvantages of series and parallel arrangements are summarized below.

Comparison of parallel and series installations for ground loops

System Configuration	Advantages	Disadvantages
Parallel Installation	<p>Smaller pipe size.</p> <p>Less antifreeze required.</p> <p>Balanced flow distribution.</p> <p>Reduced pressure drop along shorter flow paths results in smaller pump power requirements.</p>	<p>Header lines require more complex pipe joining operations.</p> <p>Special care needed to ensure complete air removal from all flow paths when purging system at start up.</p>
Series Installation	<p>Ease of removing trapped air.</p> <p>Simplified flow path.</p> <p>Single pipe diameter entails simpler pipe fusion joints, enabling quicker installation.</p> <p>Single flow path enables purging to remove air from the loop when filling with water or antifreeze solution.</p>	<p>Longer flow path requires larger diameter pipe to minimize pressure drop.</p> <p>Requires a larger pump power.</p> <p>Requires greater antifreeze volumes.</p> <p>System capacity limited by total pressure drop from end to end, so not suitable for large building applications.</p>

3.8. Earth Loop Piping

- The most commonly used earth loop piping material is high density polyethylene (HDPE). More specifically, this piping is designated as PE3608 based on the ASTM F-412 standard.
- HDPE is a thermoplastic meaning that it can be repeatedly melted and reformed. It is easily connected using fusion techniques which ensure a leak-free joint.

- The pressure rating of this pipe is determined by its diameter ratio (DR), which is the ratio of the outside diameter divided by the wall thickness. Common DRs for HDPE tubing are 7, 9, 11, 13.5, 15.5, and 17.5.
- A diameter ratio (DR) of 11 or lower is suggested for buried portions of earth loops. DR-11 PE3608 piping has a pressure rating of 160 psi. The pressure ratings of DR-9 PE3608 tubing is 200 psi. Keep in mind that lower DRs imply greater wall thickness, and greater wall thickness creates greater thermal resistance across the pipe wall. The latter is undesirable from the standpoint of heat transfer.
- All external pipework should be insulated and sleeved. When the GSHP is delivering heat, the ground loop circuit will normally be operating below the building interior's dew point temperature. Good quality insulation and vapor sealing of internal pipework and fittings in this circuit is therefore essential to minimize condensation risks. The pipework should be configured to avoid damage if any condensation does occur.
- Pipe diameters between 20mm and 40mm are usual for closed loop systems. The pipe diameter should preferably be large enough to keep the pumping power requirement small, yet small enough to cause turbulent flow to ensure good heat transfer.
- Cross linked polyethylene tubing (a.k.a. PEX-A) can also be used for buried earth loops. In North America, the use of PEX tubing for earth loops is relatively new in comparison to non-cross linked PE3608 tubing. Being a thermoset polymer, PEX tubing cannot be joined by heat fusion (as with HDPE) and use mechanical couplings. The leakage is a potential concern.

3.9. Ground Loop Sizing

A geothermal heat pump's earth loop installation is not just a matter of burying some pipes and hooking these pipes to your geothermal heat pump. Your earth loop must be matched to the heat gain or heat loss of the building and the geothermal heat pump that it is coupled to.

Step #1

First step in sizing an earth loop is having a correct heat loss/gain calculation done. This is important to know how many BTUHs the earth loop needs to supply to the geothermal heat pump, so it can heat the building correctly. This also tells us what the flow rate through your earth loop will have to be.

Step #2

Next, analyze the local geological conditions of the soil that the earth loop will be buried in. The characteristics of soil (clay, sand, gravel, silt, top soil, and many others), and the moisture content of the soil will determine how fast it can transfer heat (the rate of thermal diffusivity) into, or out of, each linear foot of the earth loop (of a certain diameter). Wet and dense soils are preferable to dry and light soils. Water-saturated soils allow for good thermal diffusion, and thus tend to reduce the amount of buried tubing. For example, for horizontal loops: moist clay soil will usually need 600 linear feet of pipe per ton; very dry soil needs at least 1200 linear feet of pipe per ton, sometimes more; and saturated soil (where water seeps into the trench as you dig) needs 425 linear feet of pipe per ton.

A qualified and experienced soil engineer/GSHP designer will be able to access and interpret the soil information using analytical software.

Step #3

Once the length of the earth loop pipe is determined, you must calculate the total pressure loss. This includes the friction inside the pipe, the manifolds, the pipe and fittings that will be inside the building, the hose kit, and the geothermal heat pump's water-to-refrigerant heat exchanger (some have much larger pressure losses than others). Don't forget to add the friction loss caused by antifreeze viscosity and the friction loss at the lowest temperature in the heating season. The pressure loss affects the circulating pump horsepower and the operating costs.

Step #4

Designing the earth loop is a balance between how much power the circulating pump will use because of the diameter of the pipe, and how much the pipe will cost because of its diameter. If the diameter of the pipe is small, you will save money on the cost of the pipe; but since the pipe diameter is small, the pumping power needed will be high, and this will greatly increase your energy bills. On the other hand, if the diameter of the pipe is large enough so that the smallest pump can be used, the energy cost that the very small pump saves will never pay for the high cost of the larger diameter pipe.

Adjust the loop (for example, by using smaller diameter parallel loops, or different pipe and fittings inside the building if the pressure loss would cause high pumping costs).

Some basic rules are as follows:

- The length of the required piping depends on ground thermal conductivity, ground temperature, and heating and cooling power needed.
- A ground loop that is too big (tube diameter and loop length) will heat/cool effectively but will be more expensive on capital costs and require more pumping energy.
- A ground loop that is too small can ‘stress’ the energy resource, by trying to extract too much energy from too small an area, thereby reducing efficiency.
- A common minimum “design” earth loop temperature is 30°F. Increasing this temperature 3 to 5°F can significantly increase the amount of piping required in the earth loop. Decreasing this temperature will reduce the amount of tubing required, but at the expense of reduced heat pump performance. The designer must then find a balance between the fluid supply temperature and the capital cost of the ground loop.
- Most earth loops should be designed to ensure that the flow through them remains turbulent at their minimum fluid temperature. Turbulent flow provides better heat transfer between the tube wall and flow fluid. As a rule of thumb, the flow rate should be at least 2.0 US gpm for $\frac{3}{4}$ ” through 1 $\frac{1}{4}$ ” pipe, and at least 3 US gpm for 1 $\frac{1}{2}$ ” pipe to avoid laminar flow.
- As a rule, in cold climates, the earth loop length will usually be set by the heating requirement. Likewise, in warm climates, the earth loop length will typically be determined by the cooling load.

3.10. Earth Loop Working Fluids

Because the evaporators in most geothermal heat pumps can operate at refrigerant temperatures well below freezing, it is common to use an antifreeze solution rather than 100% water in earth loops. Several types of antifreeze solutions based on salts, glycols and alcohol additives have been used in geothermal systems. Each of these solutions has strengths and limitations.

3.10.1. Salt based Solutions

- Salt-based solutions of calcium chloride and potassium acetate have been used in some earlier generation geothermal heat pump systems. While offering acceptable environmental characteristics,

salt-based solutions often prove corrosive to metal components, including cast iron and copper. These solutions have also shown a propensity to leak through certain pipe joints due to their low surface tensions. At present, salt-based solutions are not widely used in geothermal heat pump applications.

3.10.2. Alcohol based Solutions

- Alcohol-based fluids include diluted solutions of methanol and ethanol. Methanol, although good from the standpoint of having relatively high specific heat, good freezing point depression and low viscosity, has the negative of high oral toxicity and is flammable, even in 20% methanol/80% water concentrations. For these reasons, some municipalities and states have specifically banned its use in geothermal earth loops.
- Ethanol solutions as low as 20% concentration are also considered flammable liquids according to NFPA standard 325. Any ethanol used for antifreeze purposes is “denatured” (e.g., rendered undrinkable through additives, some of which may be toxic). Premixed solutions of ethanol and deionized water are commercially available for geothermal applications in North America. Installers should follow all information provided by suppliers regarding handling, storage and disposal of such fluids. Although both types of alcohol-based solutions have been successfully used in geothermal heat pump systems, it is imperative to verify any local ordinances or OSHA regulations that may constrain or restrict their use.

3.10.3. Propylene Glycol

- The most widely used antifreeze in geothermal heat pump applications is a water-based solution of food grade propylene glycol. Concentrations of 20% are common. Food-grade propylene glycol is not toxic. Commercially available propylene glycol sold for use in HVAC systems contains small amounts of other chemicals called “inhibitors.” These chemicals make the solution less acidic, discourage biological growth and minimize corrosion potential. Because it is non-flammable and non-toxic, it is acceptable to

allow air-venting devices in systems containing propylene glycol to discharge directly into mechanical rooms.

3.11. Suitability of Site

Site suitability is a function of many variables and extends to include:

- Thermal conductivity (ability to diffuse heat) of the soil and rock.
- Allowable area of field (existing/future structures) including space for future capacity.
- Drilling conditions (slope of site, trees).
- Species of flora with aggressive root systems should be removed from the proposed site.
- Quantity and diversity of heat to be rejected to the field.

When considering suitability of the site, all underground and above ground services, both present and future, need to be taken into account. An allowance should be made at the plant room header for connecting a cooling tower at a later date, should extra capacity be required and where an additional field loop is unable to be laid.

The number and depth of bore holes required will depend on the type of soil or rock and their formations below the proposed site, as well as the peak heat capacity to be rejected. A checklist for what should be performed in the geotechnical survey includes:

- A check to determine if underground aquifers exist and to what depth standing water will rise
- Any fault lines or unusual geological formations should be noted along with any reasons why drilling on the proposed site may be inadvisable. Any other unsuitable conditions which may affect drilling or installing the proposed field should be highlighted
- Local ground stability, over time
- Advice as to what depth conventional trenching equipment can reach without requiring blasting (the trench for header pipes should preferably be dug without blasting)
- The potential variability of the geological conditions over the entire proposed field should be noted and the advisability or necessity of drilling further test holes to gain a more reliable estimate, should be stated. Site gradient, soil surface conditions and weight bearing capacity (to determine site suitability for supporting drilling machinery) should be considered.

- Soil temperature and moisture content at 5 meter intervals.

3.12. Design Precautions

- Ground heat exchanger installation
 - The installation of the ground loop heat exchanger should be carried out by a specialist contractor who is suitably qualified in the following areas:
 - ✓ Boring of vertical holes, horizontal trenching and back fill
 - ✓ Heat fusion of the high density polyethylene pipework
 - ✓ Pressure grouting of vertical bores
- Site management
 - During the drilling of vertical bore holes, a significant amount of water can be expelled (particularly if aquifers are present). Allowance should be made for the capture, treatment and removal of this waste-water. Treatment of this waste-water usually entails provision of silt traps and pump stations to prevent silt entering local storm water drains. Drilling equipment can generate excessive noise levels which may cause noise pollution problems, both on site and for adjoining properties.
- Thermal changes
 - Geothermal heat pump systems are not suitable for 24-hour operation over extended periods, unless during that period heating and cooling is performed. Continued heat extraction or dumping can result in a sustained change in the temperature of the field, and associated loss in system performance. To avoid this, field needs time to regain thermal equilibrium with the surrounding earth. An annual heat balance is desirable. That is, during summer the earth is heated while during winter the earth is cooled, in this way the net thermal balance is maintained. If the earth is just continually heated, its capacity to act as a heat sink will progressively reduce over time. This will vary depending on geographic location and heat load diversities.

3.13. Installation Costs

Installation costs vary according to site conditions, ground structure, size of heat exchanger and appointed contractor. As a rule of thumb, the following unit rates are suitable for preliminary costing purposes.

Drilling, piping and grouting for vertical bore holes is in the order of \$22–\$25 per vertical meter. Allow \$80–\$90 per bore hole for the horizontal header pipework and \$50–\$65 per meter of pipe for the horizontal trenching from the building line to the ground heat exchanger field.

3.14. Commissioning

In the commissioning process, the function of all components should be checked and confirmed as fully operational. The ground loop, if correctly designed and constructed, will not require flow balancing. The fitting of balancing valves and other similar devices should only be installed where they are necessary because of the type of system being installed, as dictated by site and installed equipment characteristics or constraints.

The system owner should be instructed in the use and maintenance of the system and who to contact for post-installation support and advice.

The location of all buried pipes should be recorded and mapped in order to prevent future works disrupting or damaging the ground loop.

3.15. Decommissioning

A standard ground loop installation is expected to have an operational life of over 50 years and potentially more than 100 years. In the event that a particular system is being retired from active use, it is important that the system is appropriately decommissioned.

An unused and un-drained ground loop will eventually deteriorate and could leak antifreeze, or in the case of a DX system, refrigerant. There is also potential for future construction works to rupture an inactive loop if records of the location of the loops are not available. Leakage poses a potential threat to the environment, especially to groundwater resources.

All fluid in the ground loop should be displaced, removed and appropriately disposed of at the end of active service.

For vertical loops, following removal of the working fluid, a hole should be excavated at least 1.5m below the ground surface around the pipe, and this section of pipe

removed. The remaining pipe should be completely filled with high solids bentonite slurry. The slurry should be allowed to spill into the excavation to provide a cap at least 0.3m thick above the pipe. The remainder of the excavation should be filled with compacted earth or pavement.

Summarizing....

- Ground source heat pumps are not highly dependent on weather conditions and can be used effectively in most locations. However, the composition and properties of soil and rock impact heat transfer rates.
- Horizontal ground loops (generally the most economical) are typically used for newly constructed buildings with sufficient land. Horizontal slinky installations are often used for existing buildings, because they minimize the disturbance to the landscape, existing underground utilities and sprinkler systems.
- Vertical ground loop installations may be used (instead of horizontal ground loops) in areas with extensive hard rock or with soils that are too shallow to trench. However, these systems cost higher than the horizontal ground loops.
- Ground source heat pumps can be more efficient compared to air-source heat pumps (ASHP) during winter, because the temperature in the ground is higher than the ambient air temperature. COP stays stable throughout the year because the temperature does not differ much. Defrost and auxiliary heating is not required. As a GSHP has fewer moving parts, it may also enjoy a longer working life.
- The main disadvantages of ground-source heat pump systems are high capital costs and big space requirement for the pipe system. On average, a ground source heat pump costs about \$2,500 to \$3,500 per ton of capacity, or roughly \$7,500 to 10,000 for a 3-ton unit (typical residential size). In comparison, other systems would cost about \$4,000 with air conditioning.

CHAPTER – 4

4. WATER SOURCE HEAT PUMPS (WSHP)

Water source heat pumps use water as the heat source when the system is operating in the heating mode. As with air source heat pumps, an important thing to consider is the fluid that is ultimately being treated. For example, we can use heat in the water to heat air, or water. When we use heat in water to heat air, we call that heat pump a water-to-air heat pump. When we use the heat in water to heat water, we call that heat pump the water-to-water heat pump.

Water Source heat pumps (WSHP) harvest their low grade energy from the ground water, rivers, lakes or ponds. As with ground source heat pumps, the main advantage of water source heat pumps is that the temperature of groundwater or surface water (in certain depth) stays stable throughout the year. The excellent thermal properties of water enable WSHPs to operate at higher efficiencies than both GSHPs and ASHPs throughout the year.

In cooling mode, the WSHP could remove heat from the air and transfer it to the water. Due to the fact that the water is maintained at a temperature of 62°F (in summers), versus an outdoor air temperature of 95°F, it takes less work to transfer the heat to the water than it does to the air. Therefore, the water cooled air conditioning cycle is more efficient than the air cooled cycle. The same thing happens in winters when the heat pump will be removing heat from 62°F water compared to winter outdoor air subfreezing temperatures. The heat pump heating capacity will remain high without any auxiliary heating system. Defrost systems are not needed.

The figure below shows the approximate ground water temperatures in the USA. The undisturbed ground temperature will remain constant throughout the year below 30 ft. Above 30 ft. the ground temperature will change with the season.

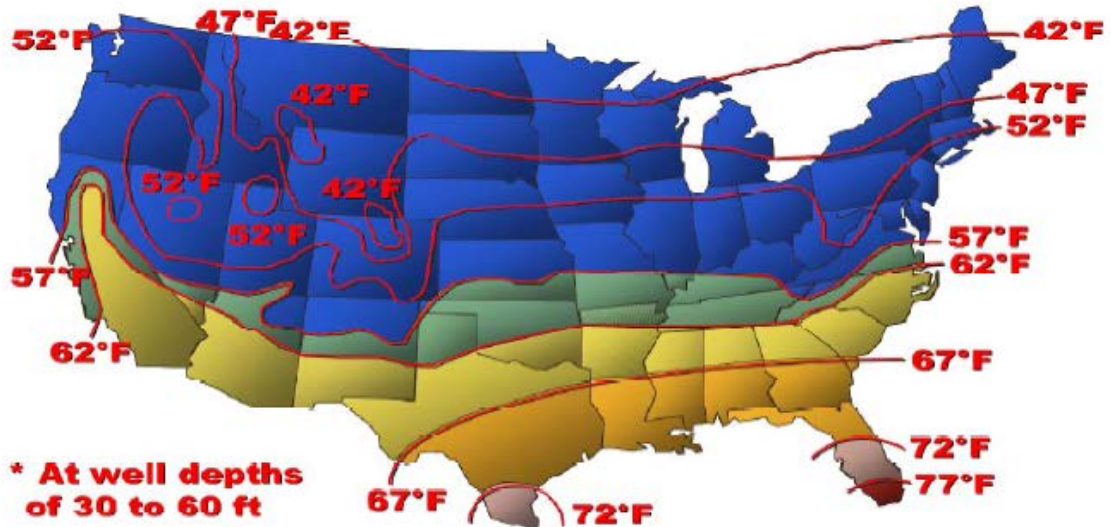

Source: U.S. Geological Survey Paper 520-FI, Washington, D.C. 1925

4.1. How does it Work?

The earth is a source of heat in the winter

- Outdoor air design temperature: 15°F
- Underground water temperature: 62°F
- Indoor air temperature: 72°F

Geothermal heat pumps transfer underground heat into buildings to provide heating.

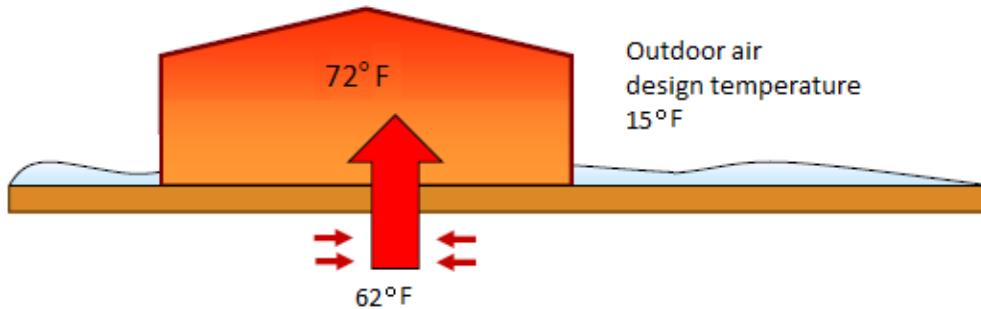

The earth is an efficient way to reject heat in the summer

- Outdoor air design temperature: 95°F
- Underground water temperature: 62°F
- Indoor air temperature: 74°F

Geothermal heat pumps transfer heat from buildings into the ground to provide cooling.

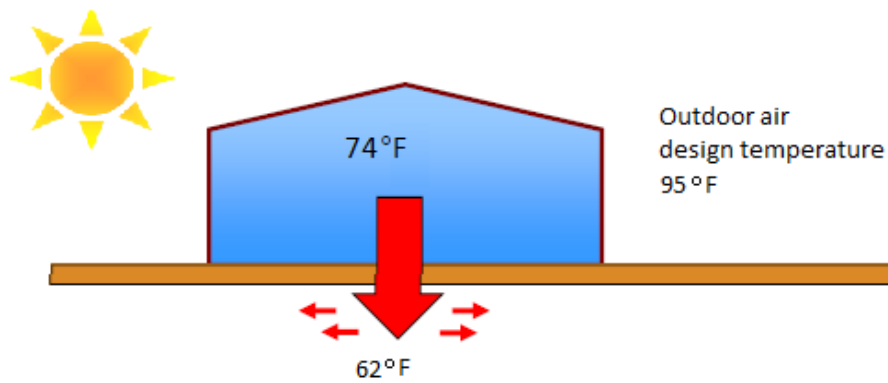

4.2. Types of WSHP Loop Systems

There are two types of geothermal heat pump classifications:

Heat pump systems that utilize ground wells are referred to as open-loop systems while those that utilize buried, water-filled loops are referred to as closed-loop systems.

Open loop systems

- An open loop heat pump system is one that utilizes a water source that is open to the atmosphere or Earth. During the heating mode, heat is transferred from the water in the Earth to the refrigerant circuit. This heat is then transferred from the refrigerant circuit to the air or water that is being heated.
- Open loop heat pump systems rely on a constant supply of water from the sources such as earth well, lake, or pond as the heat transfer medium. The water is not consumed and is discharged back into the earth/drain or dry well. Since the water does not come in contact with any chemicals or other substances within the system, no environmental damage results. It is important, though, to check with local codes and guidelines relating to the installation of this type of heat pump system.
- This procedure is simple to install, but has certain disadvantages, such as fouling of the heat exchanger unit, high maintenance, and environmental impact of the reject high temperature water to aquatic life.

- **Closed loop systems**

- A Closed loop system utilizes loops or coils of buried tubing that contain water or a water/antifreeze mixture. These loops are sealed and, if there are no leaks, will remain completely filled all the time. The water contained in these loops is used over and over to facilitate the transfer of heat either into or out of the heat pump system.
- Unlike open loop system, the system circulates the working fluid through the pipes and do not use a water source. The length of required piping depends on ground thermal conductivity, ground temperature, and heating and cooling power needed.
- The closed loop system is a popular choice when the water table is far below the ground, the ground water temperature is too low, the water quality is poor or the mineral content is too high.
- The main advantage of closed loop system over an open loop system is that there is no fouling of the heat exchanger since the closed-loop system uses the same treated water in the loops. The heat exchanger surfaces remain clean, heat transfer efficiency is not compromised, maintenance is reduced and the marine life is not endangered.
- There are four loops in a closed-loop system:
 - Water loop or ground loop – The antifreeze fluid in the loop exchanges heat with ground or water bodies (river, lakes or ponds).
 - Refrigerant loop - It exchanges heat energy with the ground loop.
 - Air Loop - It distributes the heated or cooled air to the building.
 - Domestic Hot Water Loop - It passes through the hot discharge line of the compressor and heats up the hot water tank.

4.3. Open Loop Ground Well Systems

Open loop system can be configured as single well, standing column well or double well system. Energy extraction rates are influenced by aquifer properties including flow rates and permeability and are typically around 1.5 to 3 gpm/ton (0.03 to 0.06 liter per second for each kW required).

4.3.1. Single Well System

Single-well systems rely on a single drilled well. The water is drawn from this lone well using a well pump and is circulated through a heat pump. The water after exchanging heat returns at a different temperature into the environment, soak pit or drain. An example of an open-loop single well is displayed in the figure below.

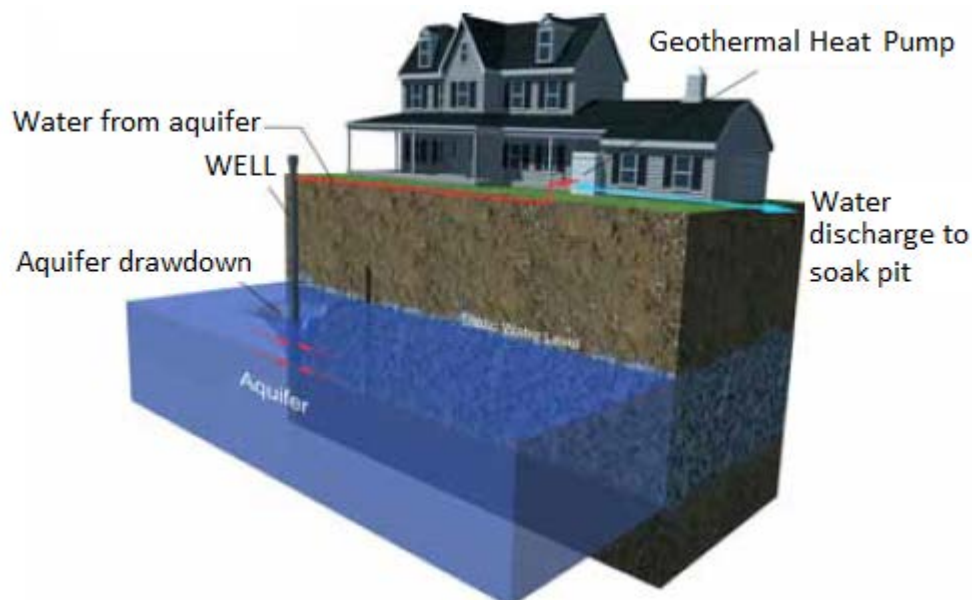

This system provides an economical solution if there is a preexisting well. In residential situations, a domestic water supply well could possibly be too small to meet the water needs of the groundwater heat pump. Residential wells typically produce 300 to 400 gallons of water per day, where a groundwater heat pump for the same residence may require thousands of gallons of water per day. A slightly modified single-well system which may alleviate some of these concerns is a standing-column well.

4.3.2. Standing Column Wells

A standing-column well uses the same concepts as a single-well system, except that in a standing-column well most to all of the discharged water is dispensed into the original well source. This minimizes the amount of water discharge from the system

into the environment. A standing-column well system is feasible when there is accessibility to fractured bedrock aquifers near the ground surface. A standing-column well typically consists of an installation of uncased boreholes 6 inches in diameter and at a depth of 1000 to 1500 feet. The surrounding aquifer is in contact with the borehole, which allows the formation of a standing column of water from the bottom of the well to the top of the groundwater table.

The water for the system is drawn from the bottom of the well and discharged into the top of the well. This allows for no net withdrawal from the groundwater itself. At times of higher demand for heating or cooling, this type of system can “bleed,” which means it returns only a portion of the water back to the well and the other portion is discharged into the surrounding environment. When this “bleeding” occurs a net groundwater inflow happens within the column. “This chills the standing column during periods of peak heat rejection (when building demand for cooling is the greatest) and/or warms it during peak heat extraction (when heating demand is greatest), thus reducing the required bore depth.

The ground area required to install a standing-column well is the least of any geothermal heat pump system, making this type of system ideal for areas with limited space and the proper geological conditions.

4.3.3. Double Well System

Double-well systems consist of both a supply and return well. Similarly, to standing-column wells, a double-well system may be used in instances where there are water discharge regulations or limits. An important design aspect of this type of open-loop system is the distance between the supply and discharge wells. A main consideration when determining the distance between the wells is the flow rate from the injection well to the production well. There may be a flow between wells, but it must be low enough so that the discharged water arriving at the production well is approximately the same temperature as the natural aquifer. Typical well spacing in a double-well system is in the range of 200 to 600 feet. This is largely dependent upon the maximum system heat/cooling loads, time span of these maximum load conditions, and the natural flow rate and thickness of the aquifer.

The figure below depicts a ground water heat pump (GWHP) system with water return to the aquifer through an injection well. Use of injection well disposal ensures the water table level is not adversely affected.

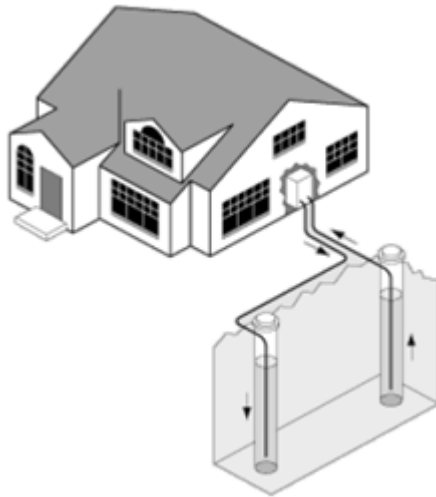

4.4. Heat Transfer from Water to Heat Pump

The water in Earth and the refrigerant in the heat pump system pass through a tube-in-tube coaxial heat exchanger. The tube-in-tube heat exchanger is configured as a tube positioned within another tube. The water flows through the inner tube while the refrigerant flows through the outer tube.



In the heating mode, heat is transferred from the water to the refrigerant, causing the refrigerant to boil to a vapor at low temperatures. In the cooling mode, heat from the hot vapor refrigerant is transferred to the water, rejecting heat from the system and allowing the refrigerant to condense into a liquid.

4.4.1. Evaluating Open Loop Ground Water Feasibility

There are three notable considerations that should be addressed when investigating this use of open loop system.

- **Water Quality**

- The first consideration is water quality. If water is contaminated i.e. contain silt, calcium carbonate, sulfur compounds, salt, iron, bacteria or other contaminant, it will gradually foul and scale the internal walls of the heat exchanger tubes. This will cause a rapid

drop in heat transfer efficiency and may even completely plug the heat exchanger.

- Where there is a possibility of contaminants in ground water, an auxiliary intermediate plate-and-frame heat exchanger is recommended along the heat pump allowing for easier cleaning and maintenance. The heat exchanger tubes should also be specified as Cupro-nickel. Open loop systems should be flushed out periodically to remove any mineral build up in the heat exchangers.

- **Well Capacity and Quantity of Water**

- The second consideration is the Quantity of water available. The required water flow through a water-source heat pump is about 1.5 to 3 gallons per minute (GPM), per ton of refrigeration [0.03 to 0.06 lps/kW]. Assuming an average of 2 GPM/ton; the water requirement will be 6 GPM for a 3-ton heat pump capacity. The annual amount of water used by a 3-ton geothermal heat pump will be about one million gallons a year. In a commercial application with numerous heat pumps, this adds up to a significant volume of water and may cause this type of system to be subject to local water-resource restrictions.
- If you are going to install the system on an existing well that already supplies water for domestic use, then the well will have to have sufficient capacity to meet the needs of both the geothermal heat pump and the domestic water usage.

- **Well Water Pumping Costs**

- The cost of the operating well pump is influenced by the suction lift or the depth of water table. The deeper the water table, the more will be the pumping power.
- The second factor influencing pump power is the type of motor. Most electric motors that are used on submersible water well pumps are permanent split capacitor (PSC). Until a few years ago, that was the highest efficiency motor available for residential use, but now there are constant pressure/ECM well pumps available. The ECM (electronically commutated motor) has a very high

efficiency and will cut the cost of pumping water by 60 percent, compared to a PSC motor. The ECM motor also makes the pump variable speed, which means your water pressure will be constant. The downside to the constant pressure/ECM pump is the initial cost. Depending on the model, the pump may cost \$1200.00 to \$1800.00.

4.4.2. Installation

All wells should have the same grouting and casing requirements as for a public or private water supply wells. All activities around the storage and installation of grouting and backfilling should seek to ensure that no chemical and microbial contamination is introduced into the well.

If clay or hardpan is encountered above a water-bearing formation, the permanent casing and grout should extend through the clay and/or hardpan.

4.4.3. Site requirements

Water in sufficient quantity and quality must be readily available. A hydrogeological analysis of the site and chemical analysis of the water will provide an indication of the suitability of the proposed water source for use as a heat source and sink.

As the water take is generally non-consumptive (i.e. will not result in any reduction in water volume at the source), the water body does not need to be large; however, it does need to be able to sustain minor temperature variations and provide enough heat energy to support heat pump function.

The location of the water (i.e. distance from the heat pump) and the quality of the water will influence WSHP system design. For example, a deep aquifer or surface water body located a long way from the heat pump unit will require greater pipe length and larger pumps to overcome the greater resistance. Efficiency losses caused by larger pump requirements should be considered.

4.4.4. Piping materials

All piping should be suitable for use in groundwater (i.e. non-toxic), corrosion proof and meet the same requirements as for public or private water supply wells. When installed in surface water, pipeline material should also be able to withstand bed erosion and flood events.

The chemical composition of the water must be taken into account when choosing pipe material. The pH, chloride ion and free oxygen levels are important. Regular cleaning to remove mineral deposits that build up on the inside of the pipes might be required. Filtration equipment or secondary heat exchangers should be used with surface water to deal with potential contaminants (e.g. sediment, detritus).

Refer to Chapter 3 for ground source pipe materials.

4.4.5. Commissioning

In the commissioning process, the function of all components should be checked and confirmed as fully operational.

The system owner should be instructed in using and maintaining the system and who to contact for post-installation support and advice.

A location map of all buried pipes and water intakes and outlets should be made and retained in order to prevent future works or activities disrupting or damaging the WSHP components.

4.4.6. Decommissioning

Any groundwater bore should be decommissioned in accordance with local authority requirements at the end of the service life. This will include backfilling/grouting requirements and may also require that specific information about the decommissioned bore be recorded and provided to the local authority having jurisdiction.

4.5. Open Loop Surface Water Systems

A surface water system uses a larger body of water like a lake, river or pond for both the water supply and discharge points. Surface water systems work by drawing water from the source to a heat pump and then returning it to the original source in such a way that the discharged water does not return to the intake. It can be a cost-effective option for those sites with access to a nearby body of water of sufficient volume to support heat pump function.

Open loop surface water systems are especially suitable for providing cooling. Thermal stratification in the deep lakes or ponds results in cold water below the thermocline remaining undisturbed throughout the year. In some cases, this water is cold enough to provide direct space cooling simply by being circulated directly through water/air heat exchangers in the building, which eliminates the need for a

heat pump. In such cases, however, building loop water temperatures must be kept below 55°F (~12°C) to dehumidify the air effectively. Data from lakes in most locations in US suggest that significant thermal stratification occurs in lakes deeper than 30 feet, with bottom water temperatures between 45 and 55 °F throughout the year, even when summer surface water temperatures reach 80 to 90 °F.

4.5.1. Design considerations

Surface water temperatures will fluctuate more with seasonal changes than ground temperatures. If the system is intended to be used for heating, an assessment of annual temperature fluctuations in the water source being considered is particularly important. If temperatures in the intake water are at risk of dropping below 46°F (~8°C), there is a risk of freezing.

The system must have a screen or filter on the intake to exclude entry of silt, debris and fauna. If used in a river the intake will also need to be designed to withstand the effects of erosion, deposition and flood events.

Finally, there must be an acceptable way to discharge the large quantity of water after it returns from the heat pumps. The discharge will affect the marine life, if high temperature water is discharged to a water body. The average Delta T for the water entering and leaving an open-loop system typically ranges from 7°F to 10°F. Local codes and regulations may limit some of the discharge practices.

4.5.2. Installation

Surface water systems generally require consents from Authority having Jurisdiction with the take and use of surface water, works on the shoreline, works on the bed of a river or lake, and for discharging thermally altered water.

Anchor blocks should be installed on the intake and discharge pipeline to ensure they remain in position despite changes in river flows or lake levels. Depending on the length of the pipe, several anchor blocks may be required to 'pin' the pipeline to the river or lake bed.

The shoreline components should be located where flood events will not damage them, and where they will not interfere with normal shoreline use. The effects of erosion caused by changes in water flow patterns around shoreline components should also be considered.

4.6. Closed Loop Submerged Systems

Closed loop systems are typically used for any site that has an access to pond, lake or river. The system comprises of a series of closed loops arranged in the spiral loop pattern, submerged in water. Heat energy is exchanged with the water body through the fluid circulating in the loop. The piping material is typically HDPE piping of $\frac{3}{4}$ - $1\frac{1}{2}$ inch (20–40 mm) diameter.

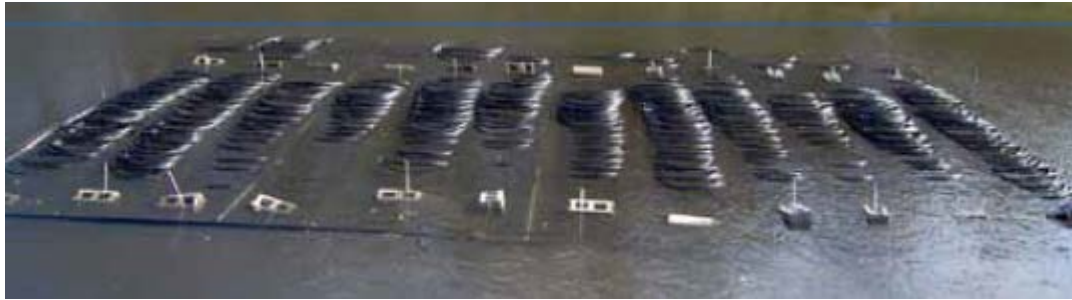

Submerged loops can be formed by coiled polyethylene pipe, mats or plate heat exchangers. Typical installations require around 300 to 500 ft. of pipe per cooling ton (27 to 45 m/kW) and approximately 3,000 ft² of surface water per cooling ton [79 m²/kW].

The water surface area requirements (i.e. the size of the water body) will vary depending on the water depth and the degree of water column stratification.

Some commercial, industrial or institutional buildings and some recreational facilities have artificial ponds for aesthetic or functional reasons and these may have adequate surface area and depth to support a submerged loop system.

Submerged water heat pumps are generally more efficient in cooling than GSHP if the water body is more than 30 feet deep. However, even deep lakes are colder in the winter than the ground, so the GSHP system performs slightly better in heating.

Submerged water heat pump systems are typically less expensive than GSHP if a suitable body of water is nearby and the water retention ponds located within the property premises is effectively utilized.

4.6.1. Design considerations

It is recommended that the coils be submerged 6 to 8 ft. (2 to 2.5 m) deep (preferably deeper) in a pond or lake and secured to concrete anchors so they float 9 to 18 in. (23 to 46 cm) above the bottom. This would ensure adequate thermal mass at times of low water conditions and also minimize the chance of damage by people using the body of water for recreational activities.

Lakes and ponds are generally preferred over river installations which may be subject to moving boulders or debris that can damage the submerged coils. Pipes must also be anchored to resist the flow of water.

4.6.2. Installation

Most installations will require that some portion of the loop is laid in the ground from the building to the water source. The guidelines for a horizontal ground loop installation for this portion of the loop should be followed.

Generally, the simplest method of installation is to fully construct the coils on land prior to submerging. The constructed pipe network can then be floated out onto the body of water until it is in position and suitably arranged ahead of sinking and anchoring in place. Concrete anchors can be used to secure the loop, preventing movement and maintaining pipe spacing.

When choosing a location for the installation, the installer should be mindful of other users of the water body, and any situation that may create a conflict in use should be avoided.

4.7. Heat Pump Interface with Water Source

Water source geothermal systems can be integrated to building heat pumps in two ways, depending on how the heat is to be transferred:

- Water to Air Heat Pump
- Water to Water Heat Pump

The first word in the category name is the media from which low-temperature heat is extracted. The word following “to” is the media to which higher-temperature heat is dissipated.

4.7.1. Water to Air Heat Pump

WATER to AIR heat pump draws heat from the water from ground well, lakes or ponds and gives it off to the air (indoor environment). The system contains two heat exchanger coils:

- Water to Refrigerant coil linked to the ground-source water loop
- Refrigerant to Air coil linked to a forced air system

- **Water to Refrigerant Coil**

The water in Earth and the refrigerant in the heat pump system pass through a tube-in-tube coaxial heat exchanger. The tube-in-tube heat exchanger is configured as a tube positioned within another tube. The water flows through the inner tube while the refrigerant flows through the outer tube.



In the heating mode, heat is transferred from the water to the refrigerant, causing the refrigerant to boil to a vapor at low temperatures. In the cooling mode, heat from the hot vapor refrigerant is transferred to the water, rejecting heat from the system and allowing the refrigerant to condense into a liquid.

- **Refrigerant to Air Coil**

Just like any other air conditioning unit, there is a fin and tube coil through which the refrigerant flows. When the heat pump is operating in the heating mode, the hot gas from the compressor is routed to the indoor coil. A blower then passes air from the conditioned space through the coil and heat is transferred from the refrigerant to the air. When the heat pump is operating in the cooling mode, the refrigerant that flows through the indoor coil is a low temperature liquid. As the blower passes air from the conditioned space through the coil, the air, being warmer than the refrigerant, transfers heat to the refrigerant, thereby cooling the air.

The figure below shows the examples of a water-to-air heat pump configured as a vertical cabinet unit. Return air enters the upper left side of the cabinet, passes through a filter and then through the refrigerant to an air heat exchanger. The conditioned air is then drawn through the blower and discharged vertically from the cabinet into a duct system. The compressor and other electrical or refrigeration system components are located in the lower portion of the cabinet.

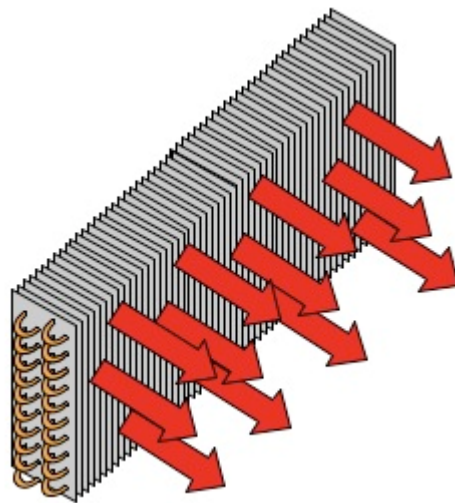
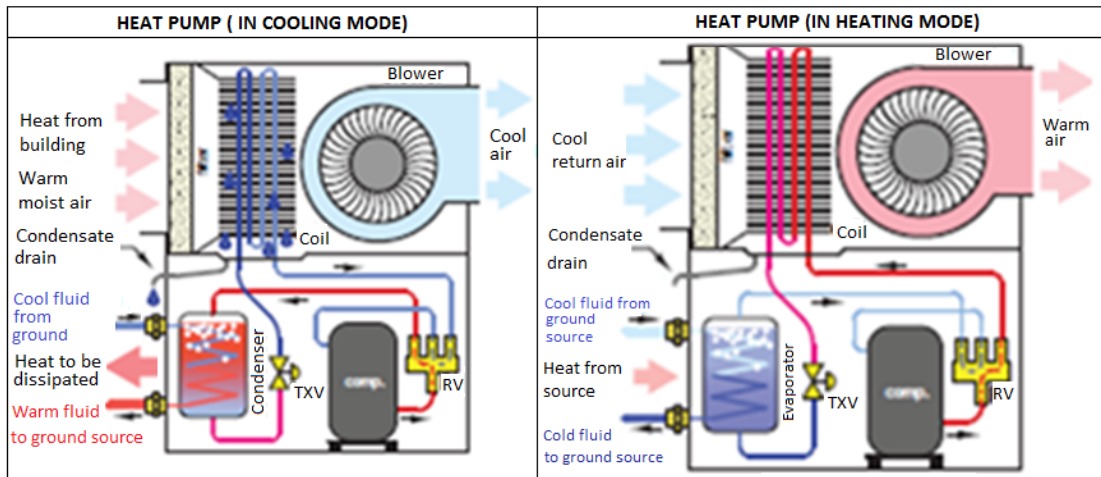

Refrigerant to Air Coil

4.7.2. Water to Water Heat Pumps

If the heat pump is being used to heat water, instead of using a fin and tube heat exchanger that was used to transfer heat to air (above), another tube-in-tube heat exchanger is used. This type of system will use a tube-in-tube heat exchanger to transfer heat between the Earth water and the heat pump and another to transfer heat from the refrigerant in the heat pump to the water being used for heating purposes.

The system contains two heat exchanger coils:

- Source Side Water-to-Refrigerant Coil – Coaxial Type
- Load Side Refrigerant-to-Water - Coaxial Type

During the refrigerant cycle, heat is transferred from the source side coaxial heat exchanger to the load side coaxial heat exchanger. The figure below shows the schematic arrangement.

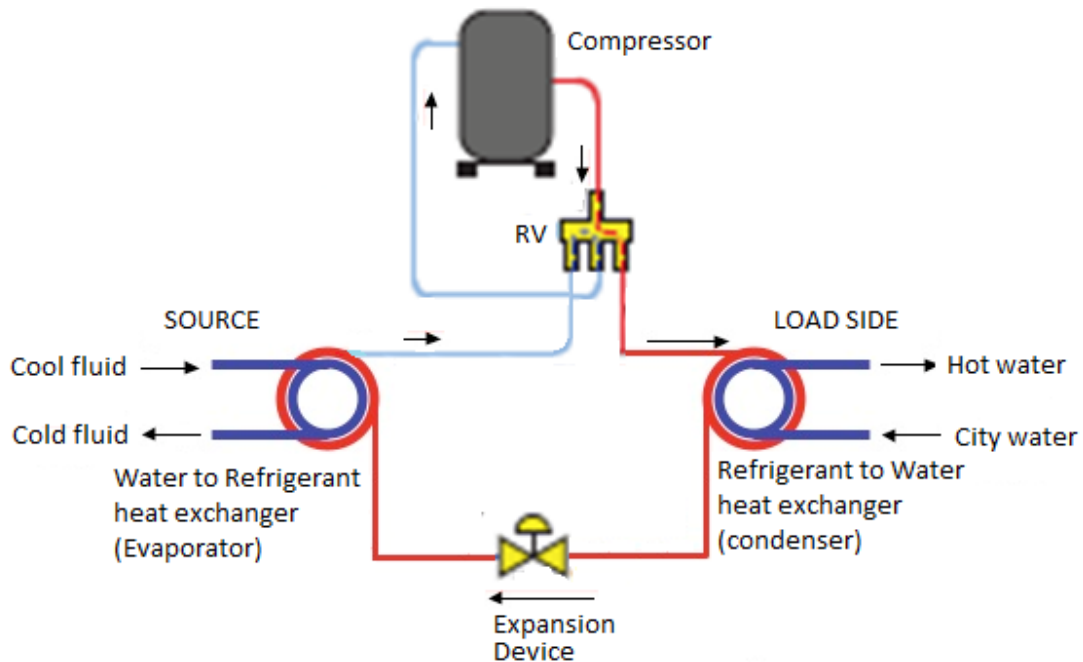

The load side provides hot water for use in bathrooms, laundry, and kitchen, as well as for pool heating or heating large areas in underfloor or wall-mounted heating systems.

4.8. Limitations

This is certainly not a type of home comfort system that will be available to anyone, but if you live in an area close to a well, lake or other natural water source, it may be an option worth considering.

Summarizing....

A water source heat pump uses ground water or surface water to transfer heat instead of extracting the heat from the outside air temperature. Water has a high capacity to hold heat in relation to its volume and allows for a high heat transfer. It is more efficient for a heat pump to exchange heat with water than air, which enables a water source heat pump to outperform an air source heat pump. The system can reach reasonably high efficiencies (300% to 600%) on the coldest winter nights, in comparison to 175% to 250% for air-source heat pumps on cool days.

According to the EPA, Geothermal heat pumps (both GSHP and WSHP) can reduce energy consumption and corresponding emissions up to 44% compared to air-source

heat pumps (ASHP) and up to 72% compared to electric resistance heating with standard air-conditioning equipment.

Geothermal heat pump systems are sheltered completely inside a building, and therefore they do not have any condensing unit or cooling tower like conventional air conditioning systems. These systems are therefore much quieter, durable and reliable. The underground piping often carries warranties of 25 to 50 years, and the heat pumps often last 20 years or more.

The drawbacks are that the initial cost of purchase and installation can be upwards of \$20,000 for a single family home before any governmental tax credits are applied. Since the earth is used as a heat transfer medium which is typically buried, repairs in the piping loop network can be costly and time consuming. It may also be necessary to seek permissions from the Environmental Agency for installation of Geothermal connectors to the heat pump.

Refer to Annexure 1 at the end of this course for summarized comparison of various Geothermal Heat Pumps.

CHAPTER - 5

5. MAJOR COMPONENTS

The major components of a vapor-compression heat pump are the compressor, heat exchangers (an evaporator and a condenser), an expansion device, fans and reversible valve. The refrigerant can also be considered a major component. Minor components are the parts that are needed but do not have an active role in the cycle process. These components are the pipes, filter, accumulator, oil separator etc.

5.1. Compressors

The compressor is the heart of a heat pump that maintains the refrigeration cycle i.e. allows refrigerant to flow through the system. It is a vapor pump, so there must be vapor at its inlet as well as vapor at its outlet. The vapor refrigerant that enters the compressor is at a low temperature and a low pressure. At the outlet of the compressor, the vapor refrigerant is at a high temperature and a high pressure. The pressure difference that is created allows the refrigerant to flow from the outlet, or discharge of the compressor through the heat transfer coils and then back to the inlet of the compressor where the pressure is once again lifted to the desired level. It can be said that the compressor acts as a dividing point between the high pressure side and the low pressure side of the heat pump system.

Since the compressors are designed to handle vapor only, an accumulator is needed to separate the liquid refrigerant from the vapor refrigerant, before this mixture enters the compressor.

Compressors can be divided into three main groups based on their type of casing.

5.1.1. Hermetic Sealed compressors

A hermetic compressor's casing is welded shut. The compressor and its motor are inside the casing in an environment that is impermeable to gas. The hermetic casing dampens the compressor noises and thus the operational noises of a heat pump. The refrigerant vapor is sucked into the casing, compressed and then let out through an opening at the other end. The welded casing is effective in keeping the refrigerant inside, but it also stores excess heat produced by the motor and prevents easy access to the compressor during maintenance. Hermetic casings are usually combined with electric motors meaning the motor comes in direct contact with the refrigerant and must be able to withhold against the refrigerant's corrosive effect.

5.1.2. Open compressors

In an open compressor, the motor is outside the compressor's casing and the two are connected by a work transferring shaft. The motor does not come into direct contact with the refrigerant, making the environment of the motor friendlier than it was in the case of a hermetic compressor. Maintenance of an open compressor is relatively easy as the motor can be attended independently. The drawback is that the compressor is little noisy and the refrigerant is vulnerable to leakage.

5.1.3. Semi-hermetic compressor

A semi-hermetic compressor is like a hermetic compressor in that the motor is placed inside the casing. However, the casing is bolted, not welded, shut. The bolted casing can be opened for maintenance reasons and when properly bolted the characteristics of a semi-hermetic compressor resemble that of a hermetic compressor.

5.2. Types of Compressors

Compressors can also be divided into two groups: dynamic or positive displacement compressors. A positive displacement compressor causes the pressure of a fluid to increase by decreasing its volume. A dynamic compressor on the other hand compresses a fluid by giving it kinetic energy and the pressure rises in accordance with the Bernoulli's principle.

The compressor may be a reciprocating type, rotary type, screw type, or centrifugal type; depending on the capacity of the unit, and whatever design advantages the engineers might have been trying to optimize for the unit.

5.2.1. Reciprocating compressor

The reciprocating compressor is a positive displacement compressor. It is made out of a piston, a compression chamber and pressure sensitive valves that allow the refrigerant to flow in and out of the compression chamber. It has the advantage of being a simple and well-known technology with high efficiencies. It can operate at high-pressure ratios and is used in versatile applications. Its disadvantages are sensitivity towards liquid slugging and dirt particles as well as the pulsation nature of the compression process and a large number of moving parts.

5.2.2. Screw compressor

A screw compressor is also a positive displacement compressor. It can have one or two screws that compress the refrigerant as it moves down the spiral. The advantages are the continuous flow of refrigerant into the compressor allowing a

continuous compression. It has a higher tolerance towards liquid slugging and has few moving parts. A screw compressor does not need suction nor discharge valves. The disadvantages include the need for precise manufacturing of helical screws.

5.2.3. Scroll compressor

Scroll compressors are also positive displacement compressors. A scroll compressor has two spirals wound together. One of the spirals remains fixed while the other rotates compressing the refrigerant. Just like a screw compressor a scroll compressor achieves a continuous flow of refrigerant into the compressor. It also has a high efficiency and is reliable. The omission of suction and discharge valves enhances its reliability. The operation of a scroll compressor is generally quieter than that of a reciprocating compressor, however it has a comparatively high cost. Both the scroll compressor and the screw compressor are extensively used in heat pump technologies.

5.2.4. Centrifugal compressor

A centrifugal compressor is a dynamic compressor. It compresses the refrigerant with centrifugal motion. The suction gas is accelerated by a rotating impeller. The accelerated gas is let into the diffuser that has a set of passages with increasing cross-sectional areas. In the diffuser, the velocity of the gas is changed into pressure as the gas decelerates. Centrifugal compressors need a steady and relatively large flow of refrigerant vapor and they have their highest efficiencies with small pressure ratios. Centrifugal compressors are normally not used for heat pumps and are generally applied to very high tonnage refrigeration system in water cooled configuration only.

5.3. Heat Exchangers

Heat exchangers are used in the heat pump cycle to transfer heat between the refrigerant and the heat sink/heat source, without allowing the two mediums to mix. In the heat pump cycle, one heat exchanger is a condenser and the other as an evaporator.

5.3.1. Condenser

The condenser is the heat exchange surface that is responsible for rejecting heat from the heat pump system so it must be warmer than the surrounding medium. Because of this, the condenser should be at a high temperature and is accomplished by maintaining the pressure of the refrigerant in the condenser at a high level.

The condensing medium can be water, air or the hybrid (combination of air and water).

- Water cooled condenser - In a water-cooled condenser, water is pumped to a cooling tower where the heat is finally rejected to the atmosphere. Water cooled system for heat dissipation is usually applied to large refrigeration system with capacity exceeding 100 tons and where good quality water is available.
- Air cooled condenser - Heat is rejected via a finned type coil heat exchanger using fans. The fans draw air through the fins the heat is transferred to the atmosphere.
- Hybrid condenser - A hybrid condenser is essentially an air-cooled condenser with a controlled amount of water sprayed onto its cooling pads to provide a measure of pre-cooling. This method enhances the performance of an air-cooled heat exchanger especially when the outdoor is very hot.

5.3.2. Evaporator

The evaporator is the heat exchange surface that absorbs heat into the heat pump system so it must be cooler than the medium being cooled. In the evaporator, the refrigerant is evaporating at a relatively low pressure, and as it does, it is absorbing latent heat from the air or water flowing over the evaporator piping.

For cooling applications, when the medium being cooled is the air in the space, a near design evaporator temperature is about 40°F. So, for R-22, the pressure in the evaporator needs to be about 69 psig in order to maintain this temperature. This assumes near design conditions, which are a 75°F indoor air temperature with a relative humidity of 50%, and an outside ambient temperature of 95°F. For heating applications, the temperature of the evaporator will vary depending on the temperature of the outside air. If the temperature of the outside air is 40°F, then the refrigerant in the evaporator will be at a temperature of about 15°F.

Heat removal from the space is accomplished in two ways:

- DX Systems - A direct expansion air conditioning (DX) system directly cools the air supplied to the building because the evaporator (containing refrigerant) is in direct contact with the supply air; and
- Hydronic Air Conditioning - Hydronic Air Conditioning is the process of producing chilled water via shell & tube or plate & fin heat exchanger and circulating the chilled water throughout a building through air cooled chilled

water coil. The indoor air is cooled via passing air across the chilled water cooling coil comprised of copper tubes bonded to aluminum fins.

5.4. Receiver

The condensed liquid refrigerant from the condenser is stored in a vessel known as the receiver from where it is supplied to the evaporator through the expansion valve or refrigerant control valve.

5.5. Expansion Device

Like the compressor, the expansion device is a system component that acts as a dividing point between the high and low pressure sides of the heat pump system. The expansion device acts as a blockage in the refrigerant circuit and restricts flow as the refrigerant flows between the two heat transfer coils. The temperature and pressure of the refrigerant at the inlet of the expansion device is high, while the temperature and pressure of the refrigerant at the outlet of the expansion device is low.

A variety of expansion devices may be used in heat pumps.

A very basic expansion device is a capillary tube. A capillary tube is a long, thin tube that is a specific diameter and length to generate a specific pressure. There are no mechanical parts; therefore, the refrigerant can flow through it in both directions.

Modern units use expansion valves (TXV) to regulate the pressure of system. It allows the liquid refrigerant under high pressure and temperature to pass at a controlled rate. The operation of a thermostatic expansion valve is governed by the temperature of the refrigerant. When the temperature rises, the temperature sensor causes the expansion valve to open up more allowing for a more rapid flow of refrigerant. The temperature sensor is mechanically connected to the valve. While they are more efficient, they generally only work when the refrigerant flows in one direction unless they are specifically designed for heat pumps. Many expansion valves have the added capability of metering the quantity of refrigerant flowing through the cycle in order to match the load to enhance the efficiency of the cycle.

5.6. Reversing Valve

The reversing valve is controlled by a solenoid coil that, when energized, causes the valve to change positions. The reversing valve has four ports:

- One port connected to the outlet of the compressor
- One port connected to the inlet of the compressor

- One port connected to one side of the indoor coil
- One port connected to one side of the outdoor coil

The reversing valve has an internal slide that ultimately determines the mode in which the system will operate.

When the system is operating in the cooling mode, the refrigerant always flows to the condenser first upon exiting the compressor. When the system operates in the heating mode, the indoor coils acts as the condenser. In this case, the hot gas from the compressor is directed to the indoor coil, which functions as the condenser.

The reversing valve is typically located at the compressor outlet (discharge). If the system is a split-type system, this location is within the outdoor portion of the system.

Do all heat pump systems have reversing valves?

No. Heat pumps that are intended to provide both heating and cooling are equipped with reversing valves. However, heat pump systems that are intended to provide only heating are not equipped with reversing valves.

Solenoid

A solenoid is basically a coil of wire. When electric voltage is applied to the coil and current flows through it, a magnetic field is generated. This magnetic field causes the reversing valve to change position. When the solenoid is energized, the system will work in one mode, and in the other mode when the solenoid is de-energized. Depending on the manufacturer of the heat pump equipment, the system mode associated with the energized or de-energized solenoid coil varies will vary.

5.7. Refrigerants

A refrigerant is a chemical substance that has the ability to absorb and reject large amounts of heat energy quickly. By controlling the pressure of the refrigerant at different points in the system, we can determine whether a particular heat transfer surface will operate as the condenser or as the evaporator.

In a heat pump system, refrigerant can be present in any one of three states: 100% liquid, 100% vapor or a mixture of liquid and vapor. When the refrigerant is a mixture of liquid and vapor, the refrigerant is said to be saturated. Each refrigerant has its own pressure/temperature relationship. Here a few of the desirable properties for a refrigerant:

The refrigerant should be non-toxic, environmentally friendly (e.g. non-ozone depleting and low global warming potential, GWP), non-flammable, chemically stable, non-corrosive, and completely miscible or not miscible with the machine oil.

A large number of refrigerant compounds exist and choosing the right refrigerant depends on the purpose of use. In the following paragraphs, a few refrigerants are presented.

- Probably, the most famous refrigerants are Chloro-Fluoro-Carbons (CFC), also called Freons. They were very popular in refrigerant technology applications for long time. However, they were found to be harmful to the ozone layer and now many of the CFC compounds are banned by law in almost all countries. R11, R12, R502 and R13B1 are examples of CFCs.
- Hydro-Chloro-Fluoro-Carbons (HCFC) are similar to CFCs. Like CFCs, HCFCs are harmful to the ozone layer and are banned in new applications. R22 and R401a are examples of HCFCs.
- Hydro Fluorocarbons (HFC) and Halogen free refrigerants are used in place of CFCs and HCFCs. HFCs do not contain chlorine and they are harmless for the ozone layer. R134a and R404a are HFCs.

5.8. Air Source Heat Pumps – Delivery Configurations

The vast majority of Air Source Heat Pumps generally fall into three distinct categories:

1. Portable Window Type Heat Pumps
2. Ductless Mini-split Type Heat Pumps
3. Ducted Split and Packaged Type Heat Pumps

5.8.1. Portable Window Type Heat Pumps

Due to their small size and relatively low cost, window-mounted or through-the-wall portable air conditioners are used in small spaces such as shops, offices as well as private residences. These are factory assembled, shop tested modular equipment that do not require field-installed connections other than fixing in a standard opening. The capacity range is about 0.5 to 2 tons (~1.75 to 7 kW).

Window heat pumps can also serve as dehumidifiers for treating moist air. If dehumidification is a major concern, consider purchasing the unit with a larger dehumidification capacity.

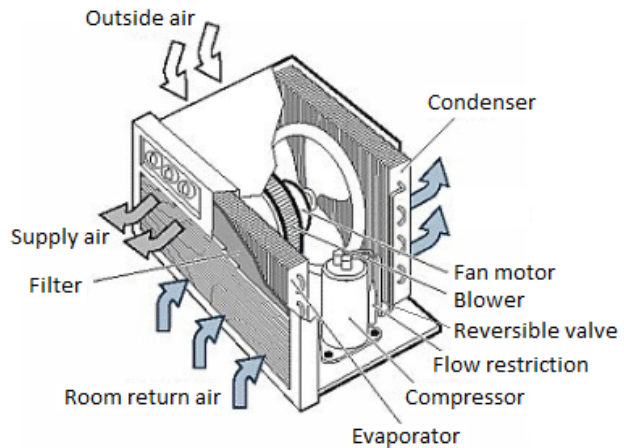

While a customer will typically select the window heat pump unit based on the cooling capacity, it is also important to pay attention to the heating capacity. This will allow selecting the right size unit for installation in a colder climate. Refer to the table below, indicating the comparison of two brands.

	Friedrich				Carrier			
Model Number	10N	12N	18N	24N	101	123	153	183
Btu/hour	8000	9400	15500	22000	9000	9800	12100	14000
COP	2.7	2.4	2.5	2.6	2.9	2.9	2.8	2.6
Heating Watts	870	1139	1824	2391	900	1000	1260	1590

Most window heat pumps also have backup electric heat for very cold weather. Heat pumps do not operate well in heating mode during extremely cold periods (less than 30 degrees Fahrenheit).

5.8.2. Ductless Mini-split Type Heat Pumps

Ductless split heat pumps are used for residential and light-commercial air-conditioning. Like standard air-source heat pumps, mini splits have two main components: an outdoor compressor/outdoor coil and an indoor air-handling unit/indoor coil. A conduit, which houses the power cable, refrigerant tubing, suction tubing, and a condensate drain, links the outdoor and indoor units.

Normally, the indoor coil operates as the evaporator coil where heat is absorbed by vaporizing or evaporating the refrigerant, and the outdoor coil operates as the condenser coil, where the refrigerant condenses into a liquid. Through the use of an electrically operated valve and some check valves, it is possible to switch the refrigerant flow, so that the indoor coil becomes the condenser and the outdoor coil

becomes the evaporator coil. The air conditioning unit is now capable of delivering heat indoors.

Ductless mini-split systems have no ducts, so they avoid the energy losses associated with the ductwork of central forced air systems. These are easier to install than some other types of space conditioning systems. For example, the hook-up between the outdoor and indoor units generally requires only a three-inch hole through a wall for the conduit. Most manufacturers of this type of system can provide a variety of lengths of connecting conduits, and, if necessary, you can locate the outdoor unit as far away as 50 feet from the indoor evaporator. This makes it possible to cool rooms on the front side of a house, but locate the compressor in a more advantageous or inconspicuous place on the outside of the building.

The main advantage of mini-splits is their small size and flexibility for zoning or heating and cooling individual rooms. Many models can have as many as four indoor air-handling units (for four zones or rooms) connected to one outdoor unit. The number depends on how much heating or cooling is required for the building or each zone (which in turn is affected by how well the building is insulated and air sealed). Each of the zones has its own thermostat, so you only need to condition occupied spaces. This will save energy and money.

The figure below shows a typical configuration with Rooms 1 & 2 connected to one outdoor unit and Rooms 3 & 4 connected to another outdoor unit.

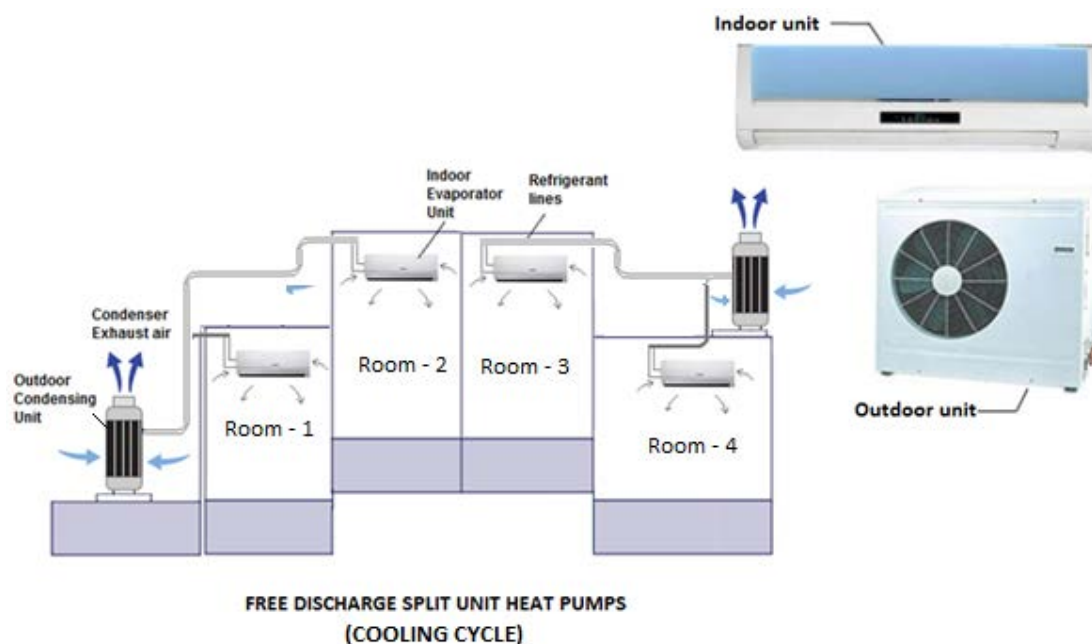

In comparison to other add-on systems, mini splits offer more interior design flexibility. The indoor air handlers can be suspended from a ceiling, mounted flush

into a drop ceiling, or hung on a wall (shown below). Floor-standing models are also available. Most indoor units are about seven inches deep and have sleek, high tech-looking jackets. Many also offer a remote control to make it easier to turn the system on and off when it's positioned high on a wall or suspended from a ceiling.



The typical range of capacities for these products is from 0.5 to 8 tons (~1.75–28 kW) for a single split, and from 2 to 40 tons (~7– 140 kW) for a multi-split unit.

5.8.3. Ducted Split Heat Pumps

Ducted split heat pumps have a duct system that supplies the conditioned air to each room of a residence or within commercial or institutional buildings. A compressor/heat exchanger unit outside the conditioned space supplies refrigerant to a single indoor coil (heat exchanger) installed within the duct system or air handler. The typical range of capacities for these products is 2 to 8 tons (~7–28 kW).

The vertical and horizontal configurations of heat pumps are shown below.



Packaged units contain an integral blower and a heat exchanger section that is connected to the air distribution system. Basic components used in the packaged equipment are the hermetic compressor, co-axial refrigerant-to-water exchanger, a finned coil refrigerant-to-air heat exchanger, a blower motor to circulate the air, and a capillary or refrigerant metering device. The system reverses from the cooling to heating cycles by means of a reversing valve.

The majority of ducted, commercial split and single package air conditioners are mounted on the roof of office, retail or restaurant buildings or on the ground adjacent to the building. The typical range of capacities for these products is 3 to 40 tons (~10.5 - 140 kW).

A thermostat signals the unit to operate on the cooling or heating cycle; the controls can be Direct Digital or analog stand alone. When the preset comfort level is achieved, the unit will turn off automatically.

Both horizontal and vertical units contain essentially the same hardware, but the horizontal units are designed for installation above a suspended ceiling or hung directly to the roof truss or can be floor or roof mounted.

The figure below depicts a vertical package heat pump unit with two modular cabinets, each located indoor and outdoor. Both heat exchangers are connected through refrigerant tubing.

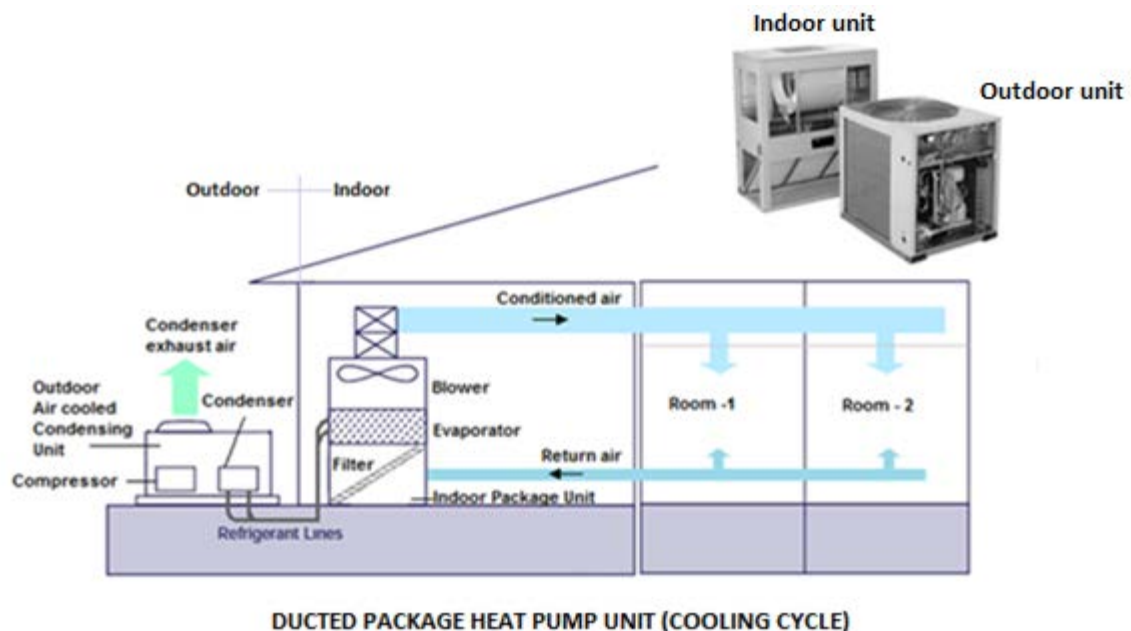

The figure below depicts a ceiling suspended horizontal package heat pump unit with two modular cabinets; one containing an evaporator located indoors and the other condenser located outdoors. Both units are connected through refrigerant tubing.

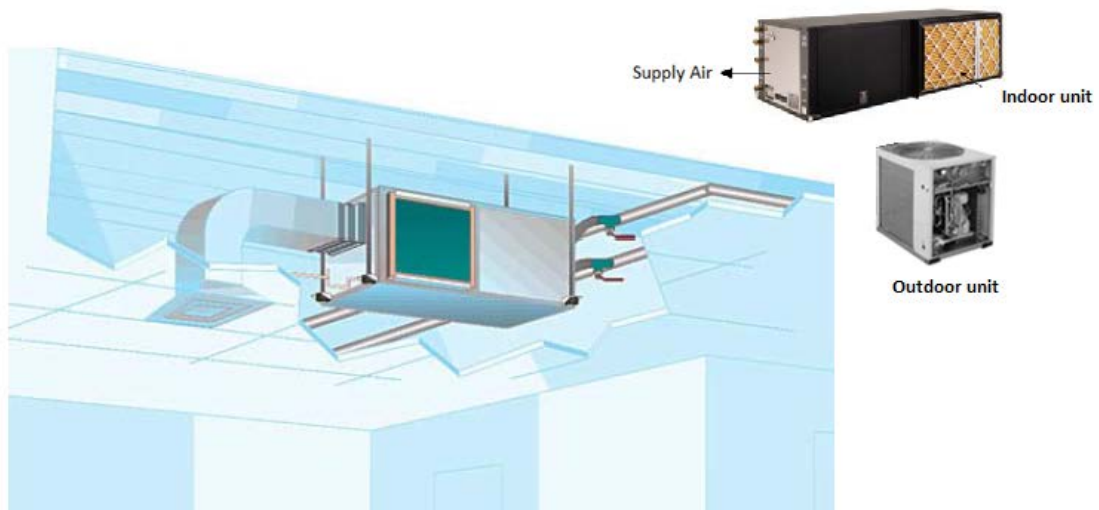

5.8.4. Sizing and Designing the Air Ducting System

Most forced air ducting systems are designed to be used with fossil fuel furnaces, with output air at about 130 to 160°F. A heat pump outputs air at about 95 to 100°F; meaning it is more efficient, but requires more airflow for proper operation. Your air ducting must be able to provide this higher airflow efficiently and without being noisy.



The total air flow through the geothermal heat pump/air ducting must be at the geothermal manufacturer's rated CFM (cubic feet per minute), and at the rated static pressure. If the air ducting is too small, the air will move too slowly, causing inefficient

geothermal operation. Simply increasing blower speed will not solve the problem, since the extra blower energy use will lower the system's efficiency and generate excessive noise. The only way to get the correct amount of air flow, with acceptable energy use, is to have large enough air ducting.

The air ducting system should also be quiet. The blower noise, or any noise that the geothermal heat pump makes, must not travel through the air ducting system. Using vibration dampers on the supply and return air ducts or plenums, and lining these areas for 5 feet in each direction with an approved sound deadening material, will usually prevent this. Also, room air registers should be sized large enough to let the air flow quietly through them. You shouldn't be able to hear your geothermal heat pump running; you should only know it is operating by the very gentle movements of your curtains.

Finally, the air ducting must provide the correct air flow to each room. Air flow is affected by the air pressure in the ducting, which is determined by the length and size of the duct, and the speed of the blower motor. Also, every room should have a return air register, or else air flow will be interrupted when the room's door is shut. For the best control of room air flow, an automatic duct damper system should be used. Automatic duct dampers open or close air ducts as a room's air flow requirements change, according to the room's thermostat. They allow each room to be kept at a few degrees warmer or a few degrees cooler than the main system setting, if the occupant desires it. They also automatically adjust for the effects of the sun shining on one side of the building, or different amounts of air infiltration from the wind, so that each room stays at the desired temperature.

Air ducts that are installed in unconditioned spaces will need to be insulated to the most recent building codes for their locale. Most new insulation codes require that air ducting in unconditioned spaces be insulated to at least R-11, and be air tight. If air ducting is installed in attic spaces, those spaces must be ventilated so the air temperature will not rise higher than a few degrees above outside temperature. If you are going to install the geothermal heat pump unit itself in any of these unconditioned spaces, you must make sure it is rated for it.

5.9. Geo-thermal Heat Pumps – Delivery Configurations

Geothermal space heating systems generally use water based hydronic heat pumps. Hydronic heat pumps, when combined with modern distribution and control systems, can serve in a wide variety of applications.

Examples include:

- Heated floor slabs with low-resistance coverings
- Heated thin-slabs over framed floors with low-resistance coverings
- Generously sized panel radiator systems with parallel piping
- High-output fin-tube baseboard

Geothermal hydronic heat pumps provide design heating output using supply water temperatures no higher than 145°F. This is much less compared to the conventional fuel boilers or hot water generators.

The following recommendations are important:

- A lower supply air temperature or a smaller temperature drop requires larger under slab piping or larger surface area of heat radiators.
- A lower flow temperature provides improved comfort by reducing the difference in surface temperature between different surfaces in the rooms.
- Also the distribution systems that supply each heat emitter using parallel piping branches, rather than series configurations, are preferred because they provide the same supply water temperature to each heat emitter.

5.9.1. Heated Floor Slab

In heated floor slab systems, the floor slab acts as thermal heat storage and it consists of closed loop tubing embedded in the concrete slab. The hot water is circulated in the tubing which provides radiant heat. The temperature of the air in the indoor areas will be warmer at the floor, and cooler as you rise toward the ceiling, which is unmatched for heating comfort. This also reduces the heat loss through the ceiling and upper walls. Because of this lower heat loss, and because a water-to-water geothermal heat pump has lower operating temperatures, these systems have the highest efficiencies and energy savings of any active heating system. The only drawback to these systems is their higher cost of installation.



The following guidelines are suggested in applications where a heated floor slab will be used to deliver heat derived from a hydronic heat pump:

- The system is generally designed for heat output of 20 Btu/ hr/ft² from a slab.
- Tube spacing within the slab should not exceed 12 inches (6 inches preferred).
- Slab should have a minimum of R-10 underside insulation.
- Tubing should be placed at approximately 1/2 the slab depth below the surface. Doing so decreases the required water temperature need for a given rate of heat output. Lower water temperatures improve heat pump performance.
- Any finished floors used should have a Total R-value of 1.0 or less

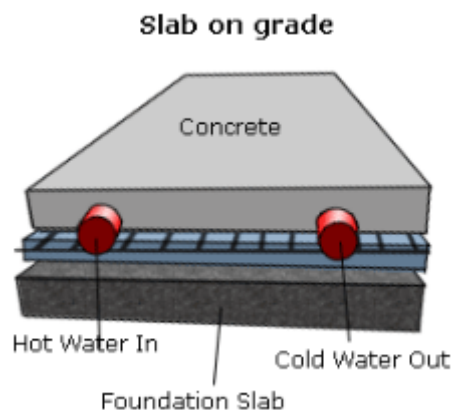

Advantages

The heat floor slab provides two important benefits: firstly, it minimizes the on-off cycling of the heat pump; secondly as the area of the heat release becomes very large, the required flow temperature of the water through the pipes becomes much less than that required by conventional radiator systems. The other advantages are:

- The system allows even heating throughout the whole floor, not just in localized spots as with wood stoves, hot air systems, and other types of radiators.
- The room heats from the bottom up, warming the feet and body first.
- Radiant floor heating also eliminates the draft and dust and allergen problems associated with forced-air heating systems.
- With radiant floor heating, you may be able to set the thermostat several degrees lower, relative to other types of central heating systems.
- There are no heat registers or radiators to obstruct furniture arrangements and interior design plans.

Disadvantages

- Does not respond quickly to temperature settings.
- Relatively expensive to install but can save money in a long run.
- Requires professional installers.

5.9.2. Heated Thin Slabs

Another common method of installing floor heating uses a “thin slab” (e.g., 1.5-inch to 2-inch slab thickness) poured over a wooden floor deck.

Because the slab is thinner than with slab-on-grade floors, it has slightly less heat dispersal characteristics. This translates into a slightly higher water temperature requirement for a given rate of heat output compared to that required for a slab-on-grade. This difference is slight. A 1.5-inch-thick concrete thin slab with 12-inch tube spacing and covered with a finish flooring resistance of $0.5^{\circ}\text{F}\cdot\text{hr}\cdot\text{ft}^2/\text{Btu}$ yields about 8% less heat output than a 4-inch-thick slab with the same tube spacing and finished flooring. This can be easily compensated for by using 9-inch rather than 12-inch tube spacing.

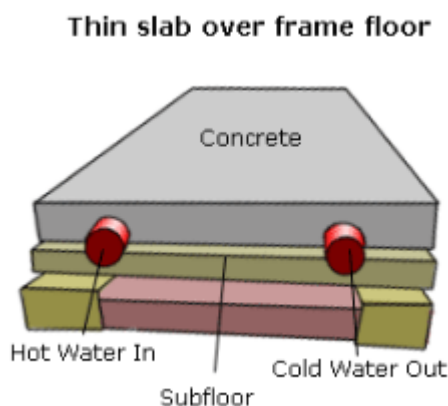

The following guidelines are recommended:

- Tube spacing within the thin slab should not exceed 9 inches.
- Floors should have a minimum of R-19 underside insulation.
- Floor finishes should have a total R-value of 1.0 or less.
- Never use “lightweight” concrete (not the same as poured gypsum under layments) for heated thin slabs.

5.9.3. Radiant Panels

Radiant panels provide high surface area relative to their rate of heat delivery and can therefore deliver design load output while operating at a relatively low water temperature.

Radiant panels can be applied on the walls or the ceiling. Ceilings have the advantage of not being covered or blocked by coverings or furniture, and thus are likely to retain good performance over the life of the building.

The rate of heat emission to the room is approximately 0.8 Btu/hr/ft² for each degree Fahrenheit the average water temperature in the tubing exceeds room air temperature. Thus, if the radiant panel operates with an average water temperature of 110°F in a room with 70°F air temperature, each square foot of wall would release about $0.8 \times (110 - 70) = 32$ Btu/ hr/ft². This performance makes it well-suited for use with hydronic heat pumps.

5.9.4. Panel Radiators

Panel radiator panel uses a convective element consisting of tubing with large surface area fins. The thermal mass of the metal and water contained in this element is very low. This allows for rapid response upon a call for heating. It also allows the unit to stop releasing heat very quickly upon a reduction or total stoppage of water flow. These characteristics are very desirable in buildings with low heat loss and the potential for significant internal heat gains from sunlight, people or equipment.



Larger panels (longer, taller and deeper) with increased surface area can be substituted to compensate for lower operating temperatures. Ultra-low mass panel radiators are also available.

The suggested guideline is to size panels so they can deliver design space heating output using a supply water temperature no higher than 120°F.

5.9.5. Low Temperature Fin based Baseboard

Fin-tube baseboards were originally developed for supply water temperatures of no less than 145°F. This is much higher than what geo-thermal heat pumps can produce. Thus, traditional fin-tube baseboard is not recommended in such applications.

However, new products recently introduced in the North American market have significantly greater fin area, which can heat water up to 145°F. It also has two tubes passing through the fins. This allows significantly higher heat out at lower water temperatures. The rated output of this element when both pipes operate in parallel is 272 Btu/hr/ft at an entering water temperature of 90°F, and 532 Btu/hr/ft at a water temperature of 120°F, with both at a total flow rate of 1 gallon per minute. The installed appearance is similar to that of conventional baseboard.

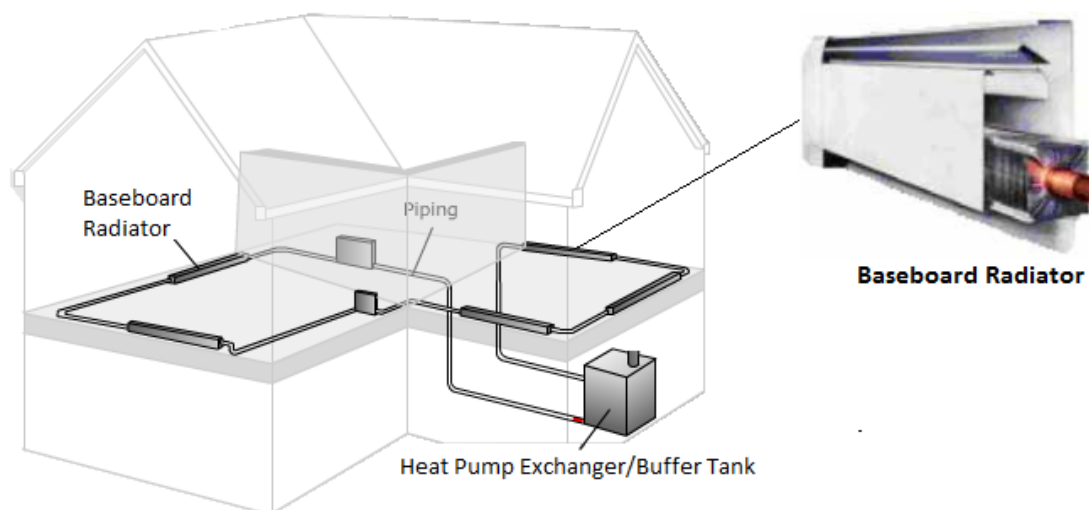

Advantages

- In general, it operates quietly.
- It delivers constant heat and doesn't stir up allergens or dust.
- Because it warms people and objects rather than just air, it feels warm even if a door is opened or a room is somewhat drafty or slightly cooler than normal.

- There is less heat loss (waste) compared to forced air system because of no leakage.

Disadvantages

- Cannot be used for cooling.
- High installation costs.
- Interference with furniture placement.
- Air entrapment can reduce efficiency.

5.9.6. Hybrid System w/ Storage Buffer

The existing buildings which cannot use slab floor heating system can use low-temperature radiators (aluminum, larger surface area or fan-coil types usually) in conjunction with a buffer cylinder. It serves to mimic the storage effect of under floor heating.

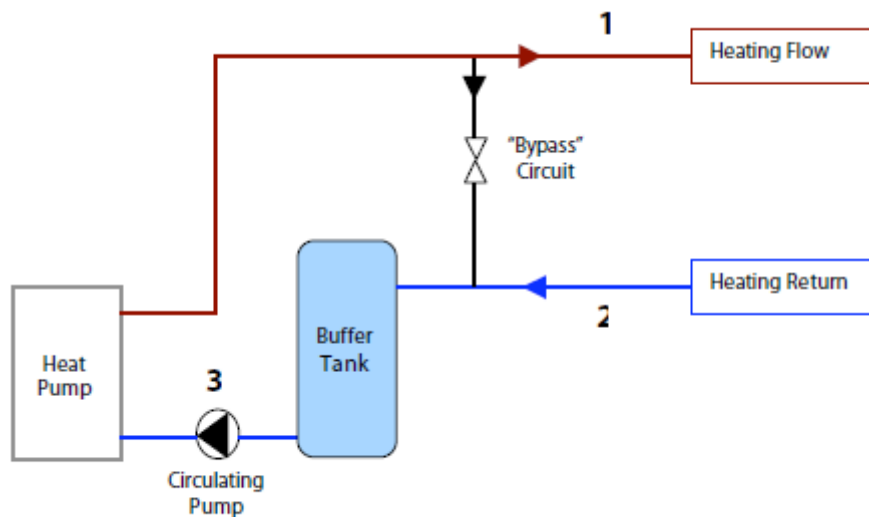

Incorporating a buffer tank into a heat pump system

The operating principle is as follows:

1. Hot water produced in the heat pump is pumped into the “heating flow”, where it is distributed around the building for heating.
2. The cooler water returning from the heating distribution system is then fed into the buffer tank on the way back to the heat pump.
3. The water is then pumped from the buffer tank back to the heat pump to complete the circuit.

Over time, as the building comes up to the required temperature, the return temperature of the water from the heating system will approach that of the hot water flow coming from the heat pump, so will the overall temperature of the buffer cylinder. The buffer cylinder stores heat, which takes the pressure away from the heat pump to switch on and off frequently.

Note: The buffer tank is located on the return side of the heating distribution system and not on the hotter flow.

This configuration allows hot water from the heat pump to enter the heating system directly, ensuring a quicker response. In certain circumstances, the buffer is more appropriately placed on the “hot” side of the heating distribution system, for example in situations where domestic hot water production is also taking place in the buffer.

Note: There is a “bypass” circuit which is a common feature of heating systems. Imagine a situation where, for example, there is a radiator system installed with thermostatic radiator valves. The water must always have a path back to the heat pump so that the pump does not pump up against a “dead-end”, and this bypass is a common method of ensuring this is possible.

5.9.7. Hydronic Systems for Cooling as well as Heating

One of the most unique benefits of all “reversible” heat pumps is their ability to provide winter heating as well as warm weather cooling. There are many ways to leverage the benefit using modern hydronic’s technology.

The most common technique is to use fan coil terminal units or air handlers with dedicated heating and cooling coil. These units are designed for concealed mounting above or below finished occupied spaces, with console units designed to be mounted on walls or ceilings.

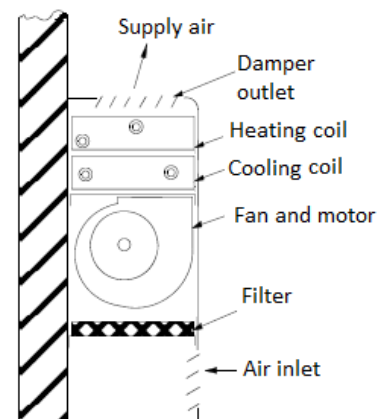

Vertical Fan Coil Unit

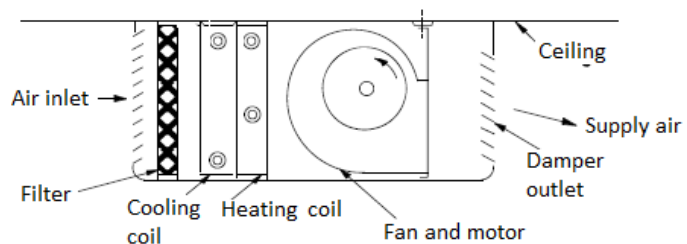

Horizontal Fan Coil Unit

Hot water produced in the heat pump at a temperature of 120°F is pumped through the heating coil. The heating coil is generally 2 rows deep.

Chilled water produced in the heat pump in the temperature range of 40° to 60°F is circulated through the cooling coil. The cooling coil is generally 3 or 4 row deep with a drip pan below to collect the moisture condensate. The reason for extended surface area of cooling coil is that the moisture removal from air (known as latent cooling) is critical in maintaining proper comfort conditions besides cooling. Moisture is removed by operating the heat exchanger below the dewpoint* temperature of the room's air.

*Note, the dewpoint temperature of air is the temperature at which the air cannot absorb and hold any more moisture. When it reaches the dewpoint temperature, the air is said to be “saturated” with moisture. Any further cooling of the air results in liquid water droplets being formed on any surface that causes this cooling. While dew formation is a perfectly natural and expected condition on outside surfaces such as a lawn in early morning, it can cause very undesirable results when it unexpectedly shows up on interior building surfaces. Thus, intentional moisture removal from inside air should only occur in properly designed chilled water terminal units that contain a “drip pan” to catch the resulting condensation and route it to a suitable drain.

5.10. Control and auxiliary equipment

Appropriate operation of the heat pump requires a control system. There are several devices to be controlled in heat pump systems, such as the compressor, fans and reversing valve. One of the main control devices of the heat pump system is a thermostat. Usually, there is a two-stage thermostat which allows the heat pump to operate under normal conditions. When the compressor cannot produce enough heat for a building, the two-stage thermostat will turn on an auxiliary backup heating system.

A room thermostat enables the operation of the heat pump at the desired level, consisting mainly of a temperature dial, temperature indicator, fan switch and system switch. Temperature dial enables the user to decide the set point for the temperature manually. The temperature indicator shows the current temperature of the room. The operation of a fan can be controlled by a fan switch and it can have an ON-mode, CLOSE-mode or AUTO-mode, for instance. The system switch allows the user to use the heat pump as a cooling or heating system. There is also an AUTO setting to ensure that the heat pump can automatically decide the cooling or heating mode.

A reversing valve is an important part of heat pumps, allowing the system to operate either on a heating or cooling cycle. When a heating cycle is on, the reversing valve allows the refrigerant to flow from the compressor to the condenser (inside coil). When the cooling mode is on, the direction of the refrigerant flow is reversed.

The defrost cycle in heat pumps requires a defrost thermostat and a defrost control device. The defrost thermostat is located outside, sensing the temperature. When the outside temperature is cold enough, the defrost thermostat closes and allows the operation of the defrost control device (or board). A defrost timer in the control board is activated in order to start the defrost cycle for a certain period of time or as long as there is frost on the system. The activation of the defrost timer energizes and activates the reversing valve to provide heat for the outside coil. The defrosting cycle can take from 1 to 10 minutes, depending on the present conditions. The defrosting cycle can be set to operate every 30, 60 or 90 minutes, in many applications.

The main control box contains all necessary relays, starting and running capacitors, transformers, compressor contactors, etc. that are required in order to achieve adequate and safe operation of the heat pump. The main control box contains also the defrost control board.

Summary

Typically, when heating systems or appliances are compared, all costs (related to the purchase, installation, operation and maintenance of these systems) that are incurred can be combined into a life-cycle cost which is the cost of ownership over a period of years. The table below compares the various types of central heating systems:

Compare	Safety	Installation Cost	Operating Cost	Maintenance Cost	Life-Cycle Cost
Combustion-Based	A Concern	Moderate	Moderate	High	Moderate
Air Source Heat Pump	Excellent	Moderate	Moderate	Moderate	Moderate
Geothermal or Ground-Source Heat Pump	Excellent	High	Low	Low	Low

Annexure -1

Advantages and Disadvantages of various Geothermal Heat Pumps

Geothermal Loop Type	Advantages	Disadvantages
Open-Loop	Simpler design; lower drilling costs than for vertical closed-loop systems; more efficient performance by avoiding thermal degradation associated with heat transfer across pipe wall from ground or water body to antifreeze solution in closed-loop; lower installation cost if a supply well already exists for domestic water or grounds irrigation, with sufficient surplus production capacity to supply heat pump system.	Subject to local, state, and Federal groundwater and surface water withdrawal and discharge permitting; large water flow requirements may exceed local water availability; supply-side of heat exchangers subject to corrosive and abrasive agents, chemical scaling, and microbial fouling; main circulating pumps typically require more power in open loops than in closed loops; water discharge regulations may preclude single-well systems or constrain the design of standing-column systems; higher installation cost if a separate injection well is required for loop water discharge.
Horizontal Closed-Loop	Trenching costs for horizontal loops usually are much lower than well-drilling costs for vertical closed-loops, and there are more contractors with the appropriate equipment; flexible installation options depending on type of digging equipment (bulldozer, backhoe, or	Largest land area requirement; performance more affected by season, rainfall, and burial depth; drought potential (low groundwater levels) must be considered in estimating required pipe length, especially in sandy soils and elevated areas; ground-loop piping can be damaged

	trencher) and number of pipe loops per trench.	during trench backfill; longer pipe lengths per ton than for vertical closed loops; antifreeze solution more likely to be needed to handle winter soil temperatures.
Slinky Closed-Loop	Slinky loops require less land area and less trenching than other horizontal-loop systems, and installation costs may be significantly less.	Greater pumping energy needed than for straight horizontal-loops; backfilling the trench while ensuring that there are no voids around the pipe coils is difficult with certain types of soil, and even more so with upright coils in narrow trenches than with coils laid flat in wide trenches.
Vertical Closed-Loop	Requires less total pipe length than most other closed-loop systems; requires the least amount of land area; seasonal soil temperature swings are not a concern.	Cost of drilling is usually higher than cost of horizontal trenching, and vertical-loop designs tend to be the costliest GHP systems; potential for long-term soil temperature changes if boreholes not spaced far enough apart.
Submerged Closed-Loop	Can require the least total pipe length and can be the least expensive of all closed-loop systems if a suitable water body is available.	Submerged loops are likely to require more regulatory permitting than buried closed-loop systems; unless properly marked, can be damaged by boat anchoring.
Direct-Exchange Loop	Higher thermal efficiency; no liquid/liquid heat exchangers required; less land area	Soil in contact with ground loop subject to freezing; copper tubing should not be buried near large

	needed for horizontal configuration.	trees where growing root system could damage the coil; ground-loop leaks can lead to catastrophic loss of refrigerant; smaller supporting infrastructure in GHP industry, with greater care and higher skill needed to install and consequently higher installation costs.
Closed-Loop In Series	Single pipe diameter entails simpler pipe fusion joints, enabling quicker installation; single flow path enables easier purging to remove air from the loop when filling with water or antifreeze solution.	Longer flow path requires larger-diameter pipe to minimize pressure drop and maintain pump power at reasonable levels; larger diameter also entails greater antifreeze volumes; system capacity limited by total pressure drop from end to end, so not suitable for large building applications.
Closed-Loop In Parallel	Shorter flow paths enable smaller pipe diameter to be used, which lowers unit piping cost and requires less antifreeze; reduced pressure drop along shorter flow paths results in smaller pump power requirements.	Header lines must be larger diameter than individual loops and so require more complex pipe joining operations than series installation; special care needed to ensure complete air removal from all flow paths when purging system at start-up.